

RoHS Compliance

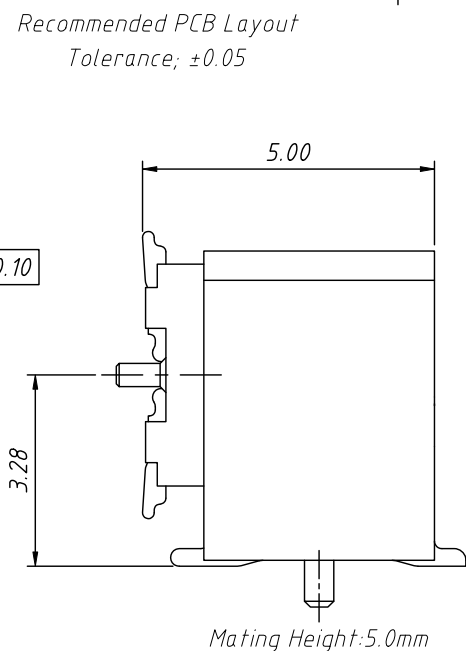

NO, of Pins	Dimensions			
	A	B	C	D
4	2.50	0.50	2.50	1.70
6	3.00	1.00	3.00	2.20
8	3.50	1.50	3.50	2.70
10	4.00	2.00	4.00	3.20
12	4.50	2.50	4.50	3.70
14	5.00	3.00	5.00	4.20
16	5.50	3.50	5.50	4.70
18	6.00	4.00	6.00	5.20
20	6.50	4.50	6.50	5.70
22	7.00	5.00	7.00	6.20
24	7.50	5.50	7.50	6.70
26	8.00	6.00	8.00	7.20
28	8.50	6.50	8.50	7.70
30	9.00	7.00	9.00	8.20
32	9.50	7.50	9.50	8.70
34	10.00	8.00	10.00	9.20
36	10.50	8.50	10.50	9.70
38	11.00	9.00	11.00	10.20
40	11.50	9.50	11.52	10.70
42	12.00	10.00	12.00	11.20
44	12.50	10.50	12.50	11.70
46	13.00	11.00	13.00	12.20
48	13.50	11.50	13.50	12.70
50	14.00	12.00	14.00	13.20
52	14.50	12.50	14.50	13.70
60	16.00	14.50	16.50	15.70
70	19.00	17.00	19.00	18.20
80	21.50	19.50	21.50	20.70

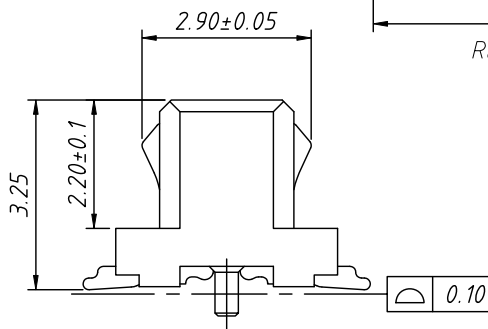
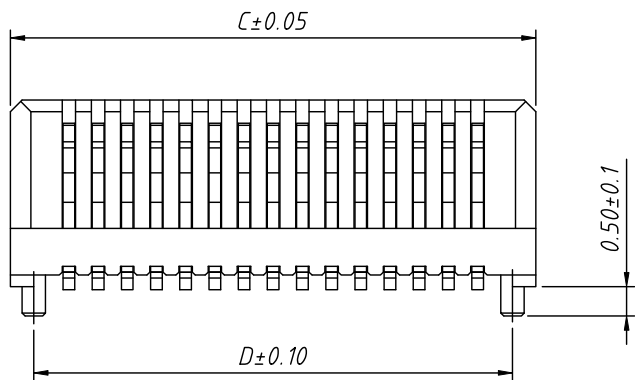
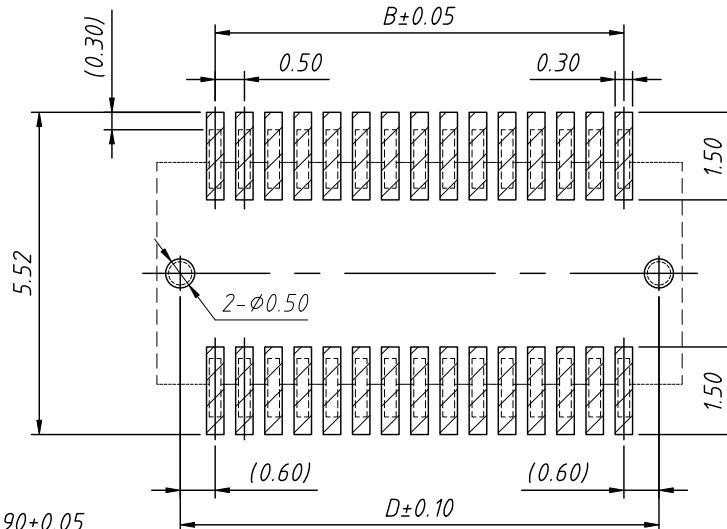
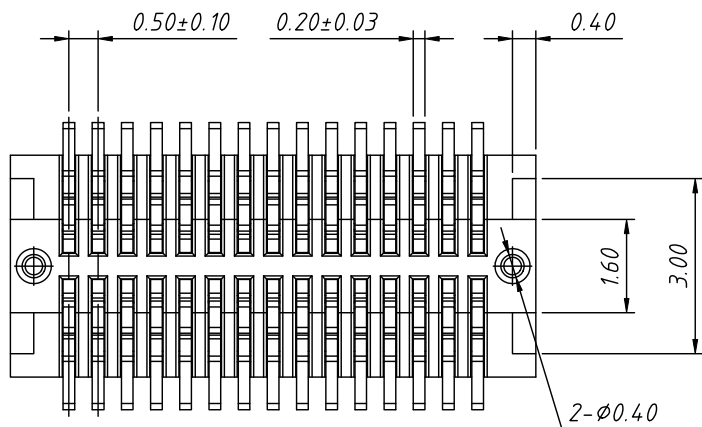
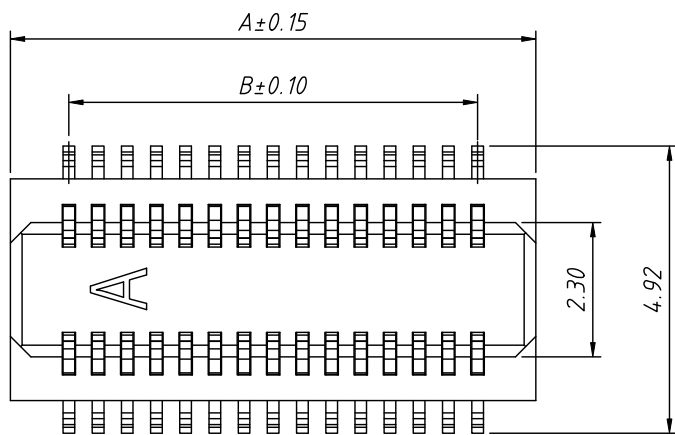

- Notes:
- Housing: LCP HIGH-TEMP Thermoplastic UL94V-0. Color: Beige
 - Terminal: Phosphor Bronze Plating: 1u" Gold Flsah Overall 50~100u" Nickel Under Plated.

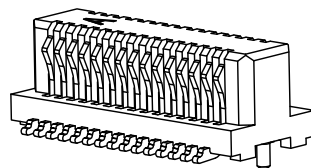

3D View

L-KLS1-B0805-325 M XXP-TR

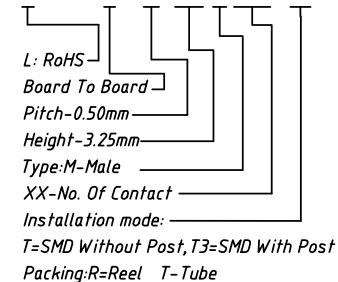

ANGLE TOLERANCE	PROJECTION	Description:		
±3°			0.5mm Board To Board Plug	
GENERAL TOLERANCE	UNITS	mm	KLS P/N:	L-KLS1-B0805-325MXXP-TR
x.x ±0.30	SHEET SIZE	A4		
x.xx ±0.20	Draw:	Daniel	2022-06-14	
x.xxx ±0.10	Check:	Daniel	2022-06-14	

NingBo KLS ELECTRONIC CO.,L TD.

RoHS Compliance

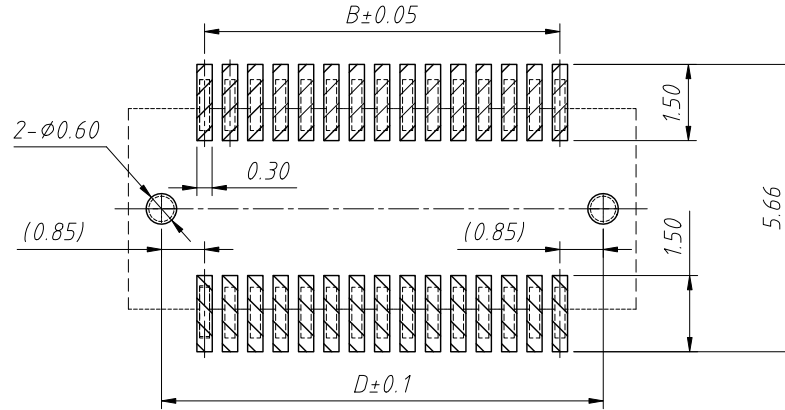
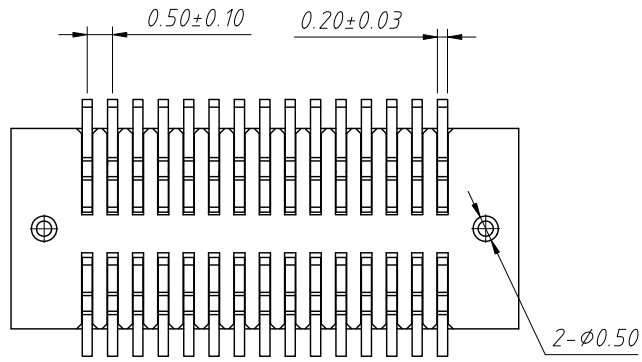

Recommended PCB Pattern Dim
Tolerance; ±0.05

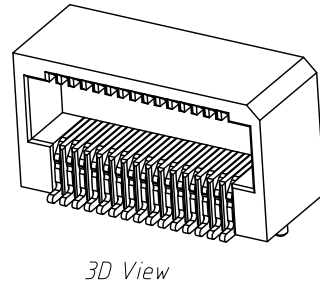
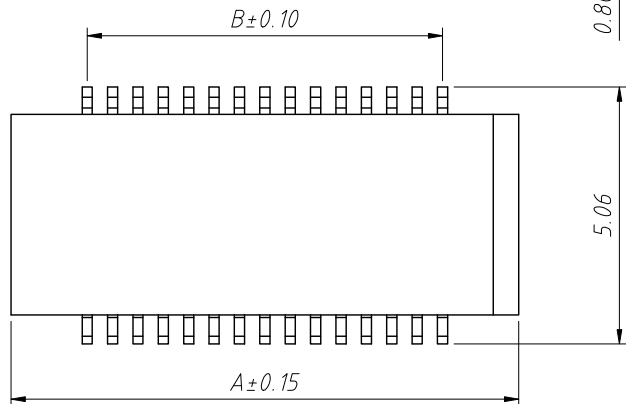
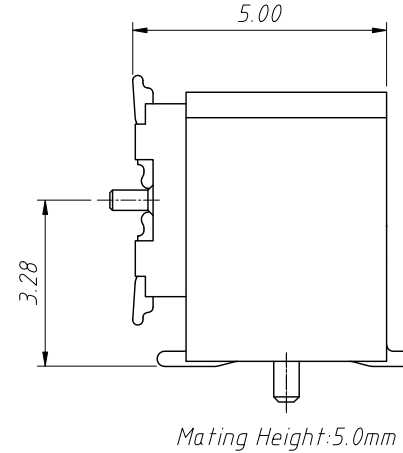
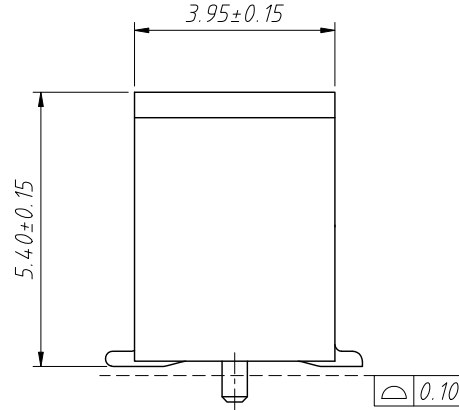
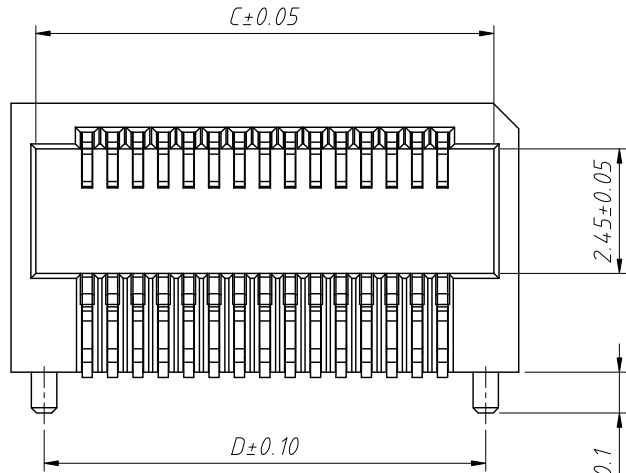

3D View

NO, of Pins	Dimensions			
	A	B	C	D
4	3.50	0.50	2.52	2.20
6	4.00	1.00	3.02	2.70
8	4.50	1.50	3.52	3.20
10	5.00	2.00	4.02	3.70
12	5.50	2.50	4.52	4.20
14	6.00	3.00	5.02	4.70
16	6.50	3.50	5.52	5.20
18	7.00	4.00	6.02	5.70
20	7.50	4.50	6.52	6.20
22	8.00	5.00	7.02	6.70
24	8.50	5.50	7.52	7.20
26	9.00	6.00	8.02	7.70
28	9.50	6.50	8.52	8.20
30	10.00	7.00	9.02	8.70
32	10.50	7.50	9.52	9.20
34	11.00	8.00	10.02	9.70
36	11.50	8.50	10.52	10.20
38	12.00	9.00	11.02	10.70
40	12.50	9.50	11.52	11.20
42	13.00	10.00	12.02	11.70
44	13.50	10.50	12.52	12.20
46	14.00	11.00	13.02	12.70
48	14.50	11.50	13.52	13.20
50	15.00	12.00	14.02	13.70
52	15.50	12.50	14.52	14.20
60	17.50	14.50	16.52	16.70
70	20.00	17.00	19.02	18.70
80	22.50	19.50	21.52	21.20

Notes:

- Housing: LCP High-Temp Thermoplastic, UL 94V-0, Color: Beige
- Terminal: Brass Bronze, Plating: 1u" Gold Flash Overall
50 ~ 100u" Nickel Under Plated

L-KLS1-B0805-540 F XXP-TR

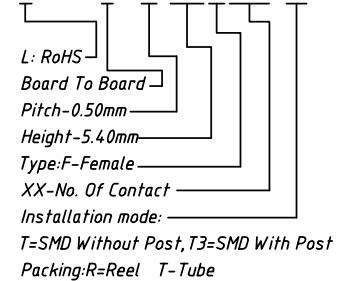

ANGLE TOLERANCE	PROJECTION	Description:
±3°		0.5mm Board To Board Socket
GENERAL TOLERANCE	UNITS	mm
x.x ±0.30	SHEET SIZE	A4
x.xx ±0.20	Draw:	Daniel 2022-06-14
x.xxx ±0.10	Check:	Daniel 2022-06-14

L-KLS1-B0805-540 FXXP-TR



NingBo KLS ELECTRONIC CO.,L TD.