

RoHS Compliance

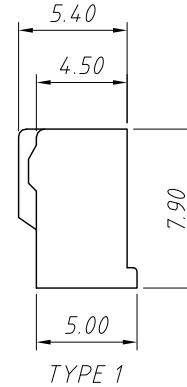
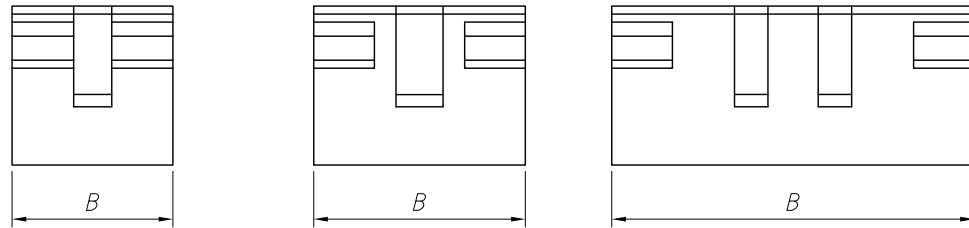
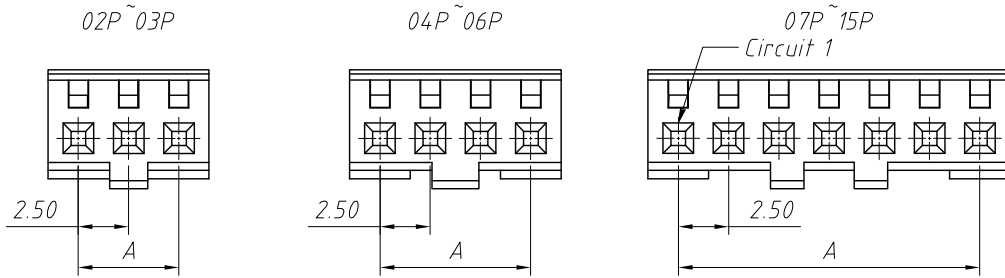

Pin	Dimensions(mm)	
	A	B
02	2.50	5.50
03	5.00	8.00
04	7.50	10.50
05	10.00	13.00
06	12.50	15.50
07	15.00	18.00
08	17.50	20.50
09	20.00	23.00
10	22.50	25.50
11	25.00	28.00
12	27.50	30.50
13	30.00	33.00
14	32.50	35.50
15	35.00	38.00

Material:
Housing:PA66,UL94V-0

Electrical Characteristics:
Rated Current:3.0AMP
Voltage rating:500V AC,DC
Temperature range:-25°C ~ +85°C
Insulator Resistance:100MΩ Min
Withstanding Voltage:1500V AC/minute
Contact Resistance:20mΩ Max

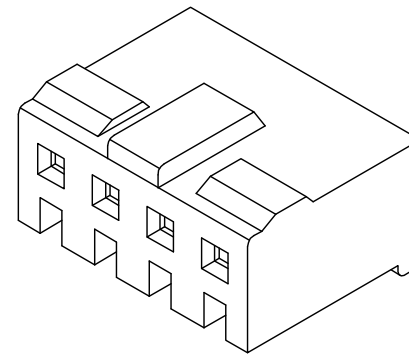
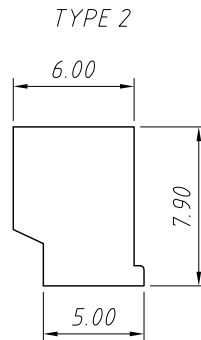
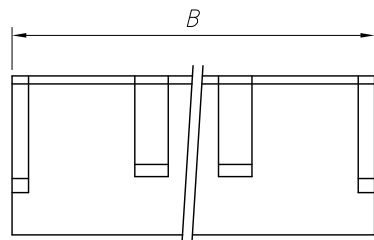
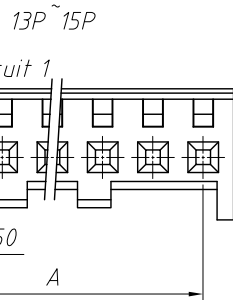

Order Information:
L-KLS1-XL1-2.50-XX-H

L: RoHS
Pitch:2.50mm
XX-No.of 02~15 pins
Type:
T-Terminal H-Hosing
S-Straight male pin
R-Right angle male pin

ANGLE TOLERANCE	PROJECTION	Description:	2.50mm Pitch IL-G Type
±3°			Wire To Board Connector
GENERAL TOLERANCE	UNITS	mm	KLS P/N:
x.x ±0.30	SHEET SIZE	A4	L-KLS1-XL1-2.50-XX-H
x.xx ±0.20	Draw:	Daniel	2021-01-11
x.xxx ±0.10	Check:	Daniel	2021-01-11



NingBo KLS ELECTRONIC CO.,L TD.

1 RoHS Compliance

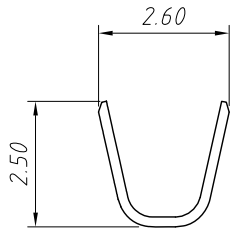
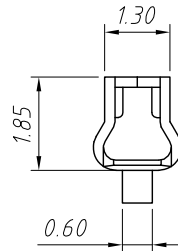
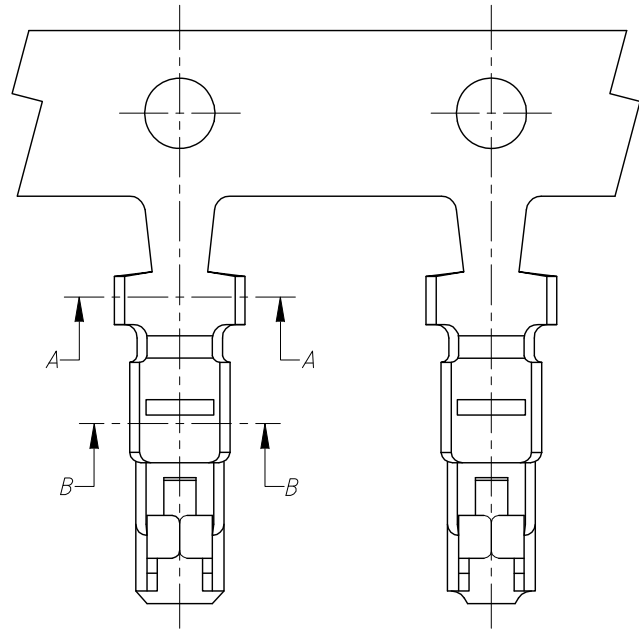

A-A

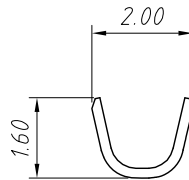

B-B

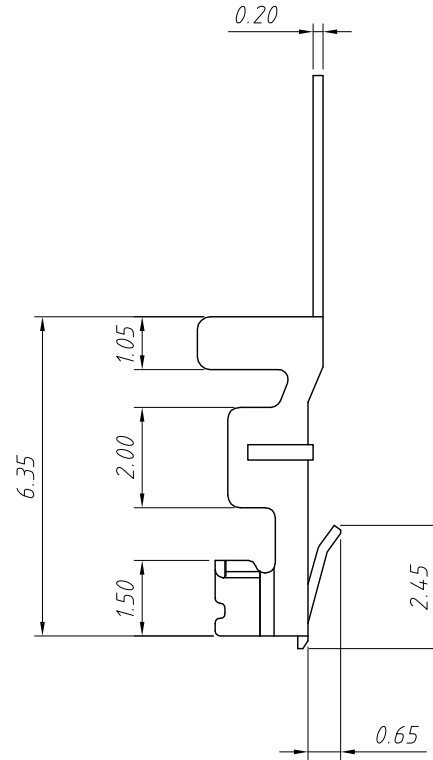

Material:
 Terminal: Phosphor Bronze
 Plating: Tin plated
 Applicable wires: AWG #22 ~ #28
 Insulation O.D: 1.7mm
 Qty/reel: 10000 pcs

Electrical Characteristics:
 Rated Current: 3.0AMP
 Voltage rating: 500V AC, DC
 Temperature range: -25°C ~ +85°C
 Insulator Resistance: 100MΩ Min
 Withstanding Voltage: 1500V AC/minute
 Contact Resistance: 20mΩ Max

Order Information:
 L-KLS1-XL1-2.50-T

 L: RoHS
 Pitch: 2.50mm
 Type: _____
 T-Terminal H-Hosing
 S-Straight male pin
 R-Right angle male pin

ANGLE TOLERANCE	PROJECTION	Description:	2.50mm Pitch IL-G Type
±3°			Wire To Board Connector
GENERAL TOLERANCE	UNITS	mm	KLS P/N:
x.x ±0.30	SHEET SIZE	A4	L-KLS1-XL1-2.50-T
x.xx ±0.20	Draw:	Daniel	2021-01-11
x.xxx ±0.10	Check:	Daniel	2021-01-11



NingBo KLS ELECTRONIC CO.,L TD.

1 RoHS Compliance

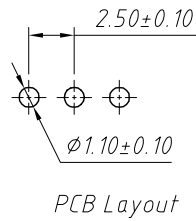
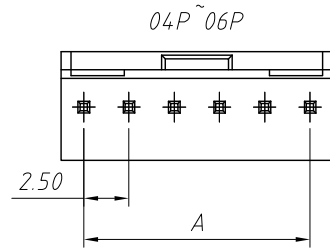
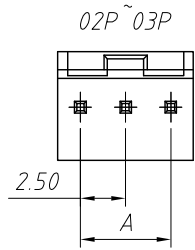

Pin	Dimensions(mm)	
	A	B
02	2.50	5.00
03	5.00	7.50
04	7.50	10.00
05	10.00	12.50
06	12.50	15.00
07	15.00	17.50
08	17.50	20.00
10	22.50	25.00
11	25.00	27.50
12	27.50	30.00
13	30.00	32.50
14	32.50	35.00
15	35.00	37.50

Material:
Housing:PA66,UL 94 V-0
Contact:Brass
Plating:Tin plate

Electrical Characteristics:
Rated Current:3.0AMP
Voltage rating:500V AC,DC
Temperature range:-25°C~ + 85°C
Insulator Resistance:100MΩ Min
Withstanding Voltage:1500V AC/minute
Contact Resistance:20mΩ Max

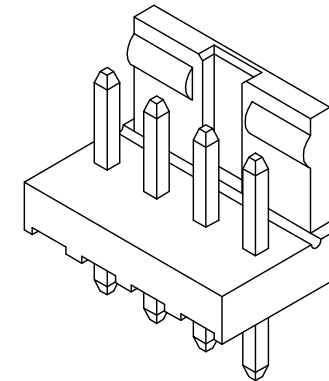
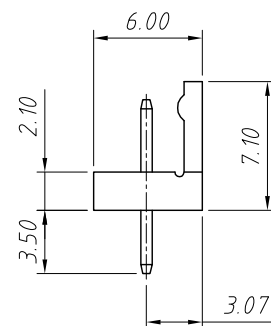
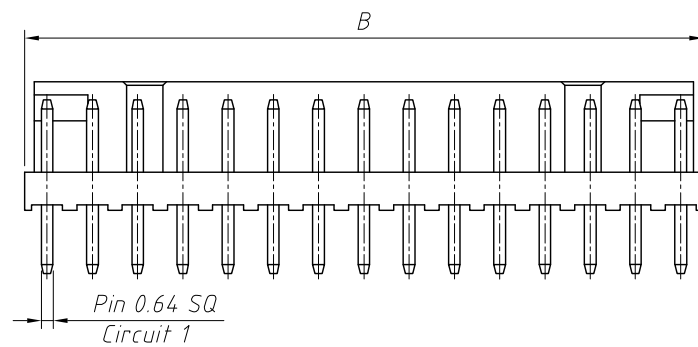
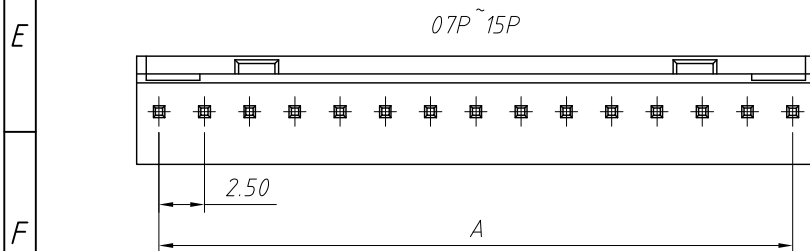
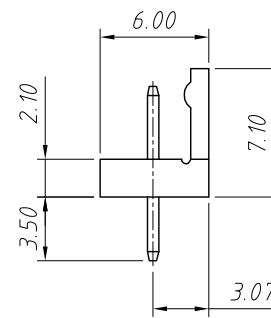
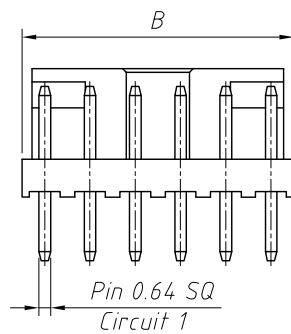
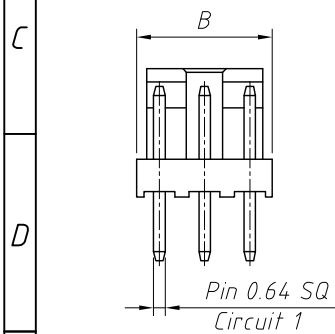

Order Information:
L-KLS1-XL1-2.50-XX-S

L: RoHS
Pitch:2.50mm
XX-No.of 02~15 pins
Type:
T-Terminal H-Hosing
S-Straight male pin
R-Right angle male pin

ANGLE TOLERANCE	PROJECTION	Description:	
±3°		2.50mm Pitch IL-G Type Wire To Board Connector	
GENERAL TOLERANCE	UNITS	mm	KLS P/N:
x.x ±0.30	SHEET SIZE	A4	L-KLS1-XL1-2.50-XX-S
x.xx ±0.20	Draw:	Daniel	2021-01-11
x.xxx ±0.10	Check:	Daniel	2021-01-11



NingBo KLS ELECTRONIC CO.,LTD.

1 RoHS Compliance

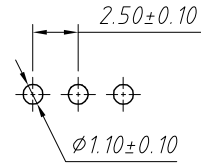
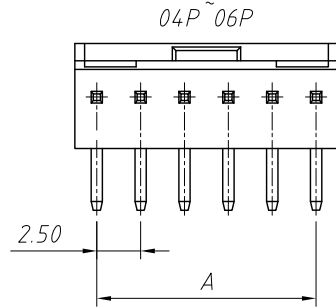
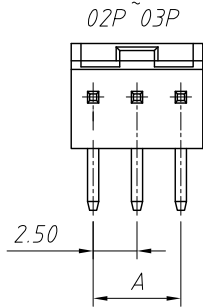

PCB Layout

Pin	Dimensions(mm)	
	A	B
02	2.50	5.00
03	5.00	7.50
04	7.50	10.00
05	10.00	12.50
06	12.50	15.00
07	15.00	17.50
08	17.50	20.00
09	20.00	22.50
10	22.50	25.00
11	25.00	27.50
12	27.50	30.00
13	30.00	32.50
14	32.50	35.00
15	35.00	37.50

Material:
Housing:PA66,UL 94 V-0
Contact:Brass
Plating:Tin plate

Electrical Characteristics:
Rated Current:3.0AMP
Voltage rating:500V AC,DC
Temperature range:-25°C~+85°C
Insulator Resistance:100MΩ Min
Withstanding Voltage:1500V AC/minute
Contact Resistance:20mΩ Max

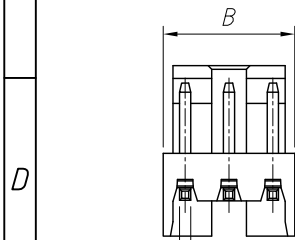

Pin 0.64 SQ
Circuit 1

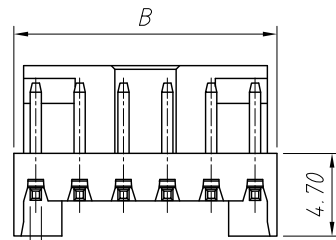

Pin 0.64 SQ
Circuit 1

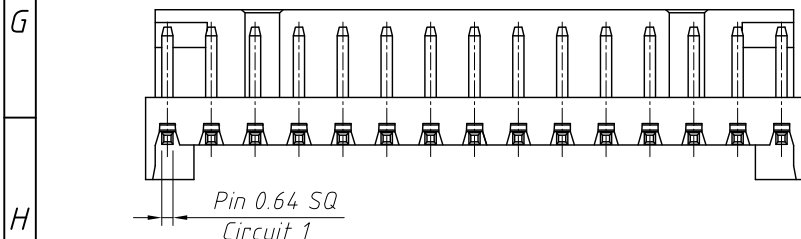
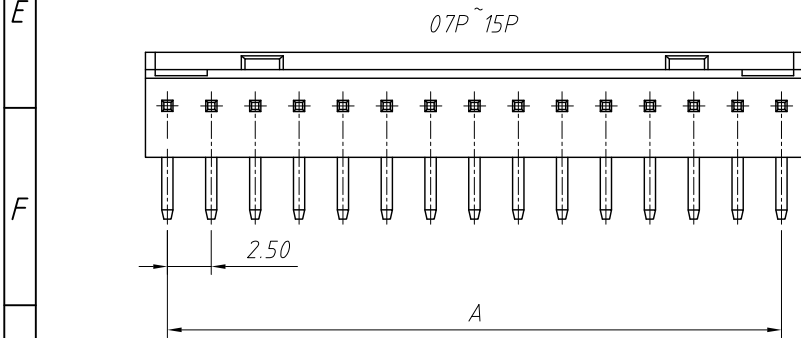
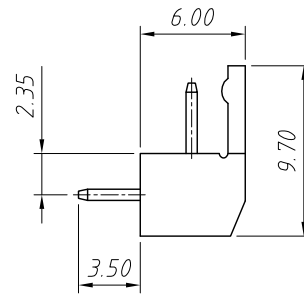

Pin 0.64 SQ
Circuit 1

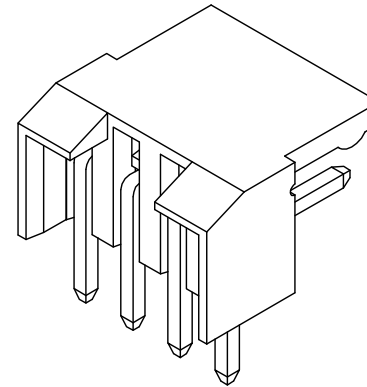
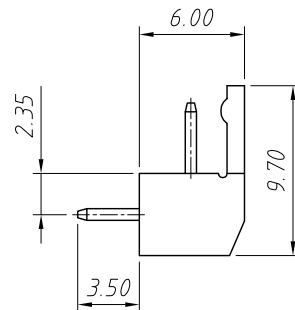

Order Information:
L-KLS1-XL1-2.50-XX-R

L: RoHS
Pitch:2.50mm
XX-No.of 02~15 pins
Type:
T-Terminal H-Hosing
S-Straight male pin
R-Right angle male pin

ANGLE TOLERANCE	PROJECTION	Description:
±3°		2.50mm Pitch IL-G Type Wire To Board Connector
GENERAL TOLERANCE	UNITS	mm
x.x ±0.30	SHEET SIZE	A4
x.xx ±0.20	Draw:	Daniel 2021-01-11
x.xxx ±0.10	Check:	Daniel 2021-01-11



NingBo KLS ELECTRONIC CO.,LTD.