

RoHS Compliance

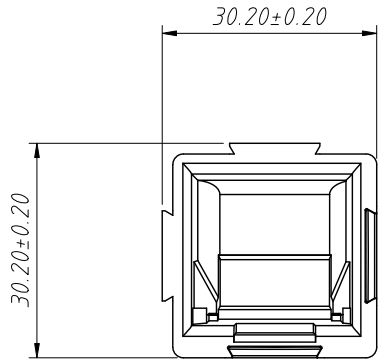

Material:
 Housing: PC, UL 94V-0
 Color: Red, Green, Black, White, Blue

Electrical Characteristics:
 Rated Current: 180A
 Rated Voltage: 600V

Applicable Terminal:
 L-KLS1-XT175-TA/T1A/T2A

Order Information:
 L-KLS1-XD180-H-R

L: RoHS
 XD Series
 Type: H-Housing
 Color:
 R-Red, G-Green, B-Black,
 W-White, L-Blue

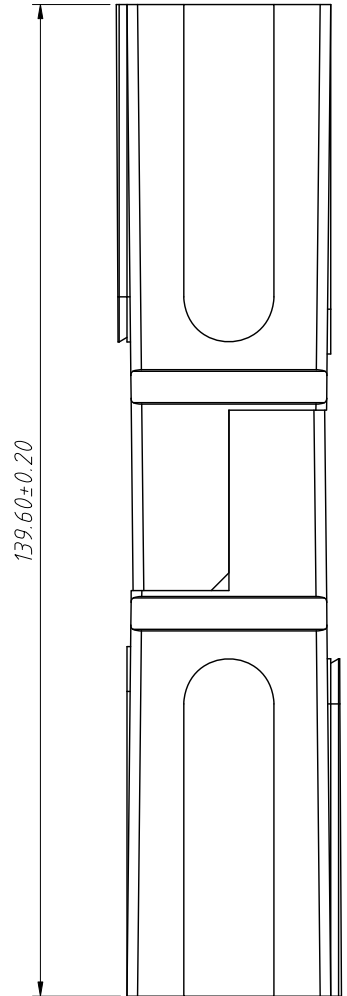
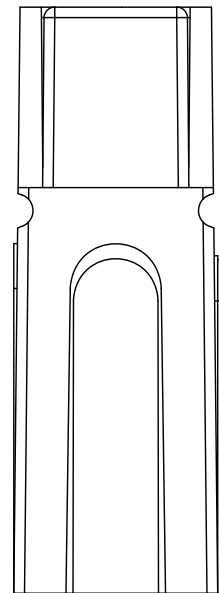
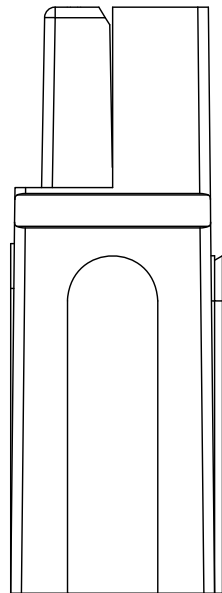
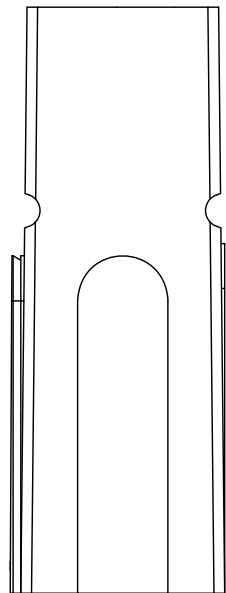
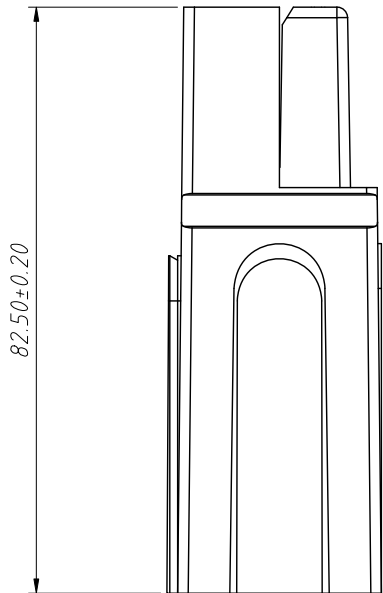

Mating Dimensions

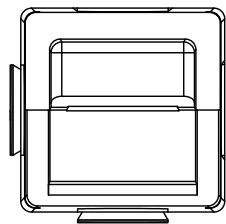

ANGLE TOLERANCE	PROJECTION	Description:	
±3°		Powerpole Connector PP180-Up to 350 Amps	
GENERAL TOLERANCE	UNITS	mm	KLS P/N:
x.x ±0.30	SHEET SIZE	A4	L-KLS1-XD180-H-R
x.xx ±0.20	Draw:	Daniel	2022-04-02
x.xxx ±0.10	Check:	Daniel	2022-04-02



NingBo KLS ELECTRONIC CO.,L TD.