

1 RoHS Compliance

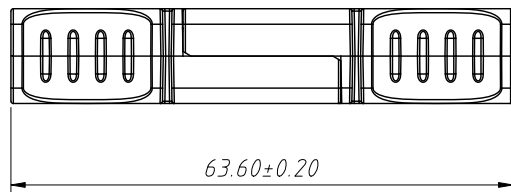
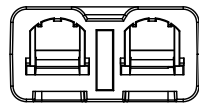
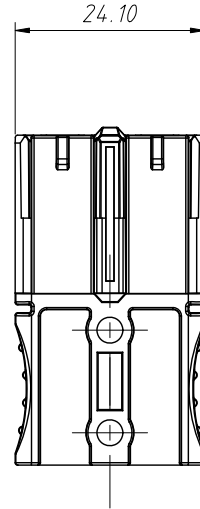
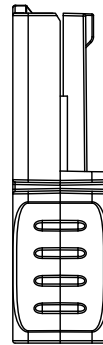
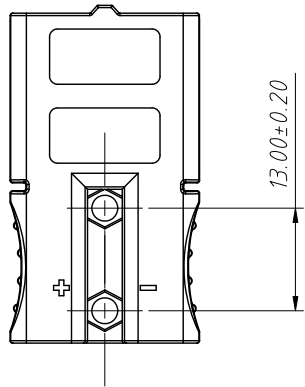
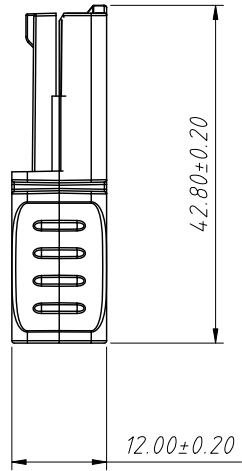
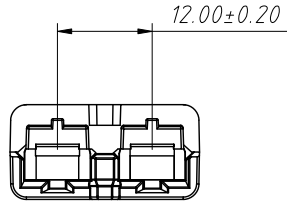

Mating Dimensions

Material:

Housing: PC, UL 94 V-0

Color: Red, Green, Black, Blue
Yellow, Orange, Grey

Electrical Characteristics:

Rated Current: 40A

Rated Voltage: 600V

Applicable Terminal:

L-KLS1-XT40-T

L-KLS1-XT40-T1

L-KLS1-XT40-T2

Order Information:

L-KLS1-XT40-H-R

L: RoHS

XT Series

Type: H-Housing

Color:

R-Red, G-Green, B-Black, GY-Grey

L-Blue, Y-Yellow, OR-Orange

ANGLE TOLERANCE	PROJECTION	Description:		
±3°		40A 600V Housing 2 Pole		
GENERAL TOLERANCE	UNITS	mm	KLS P/N:	L-KLS1-XT40-H-R
x.x ±0.30	SHEET SIZE	A4		
x.xx ±0.20	Draw:	Daniel	2022-04-02	
x.xxx ±0.10	Check:	Daniel	2022-04-02	
			NingBo KLS ELECTRONIC CO.,LTD.	

1
RoHS Compliance

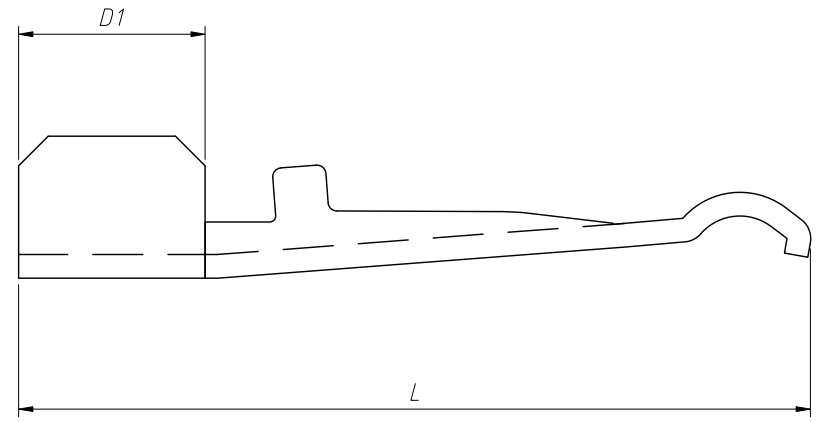
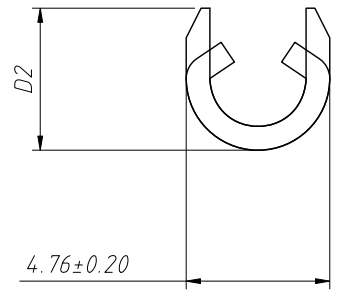

Material:
Terminal: Red Copper

Electrical Characteristics:
Rated Current: 40A
Rated Voltage: 600V

Applicable Housing :
L-KLS1-XT40-H-X

Part Number	D1 (mm)	D2 (mm)	L (mm)	Wire
L-KLS1-XT40-T	6.4 ± 0.20	3.9 ± 0.20	26.9 ± 0.20	16/20AWG
L-KLS1-XT40-T1	6.4 ± 0.20	4.6 ± 0.20	26.9 ± 0.20	12/16AWG
L-KLS1-XT40-T2	6.4 ± 0.20	5.1 ± 0.20	26.9 ± 0.20	10/14AWG

Order Information:
L-KLS1-XT40-T
L: RoHS
XD Series
Type:
T / T1 / T2-Terminal

ANGLE TOLERANCE	PROJECTION	Description:	Terminal 40A Automobile connector	
$\pm 3^\circ$				
GENERAL TOLERANCE	UNITS	mm	KLS P/N:	L-KLS1-XT40-T
x.x ± 0.30	SHEET SIZE	A4		
x.xx ± 0.20	Draw:	Daniel	2022-04-02	NingBo KLS ELECTRONIC CO.,L TD.
x.xxx ± 0.10	Check:	Daniel	2022-04-02	