

1 RoHS Compliance

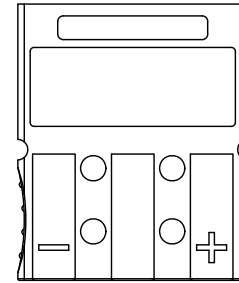
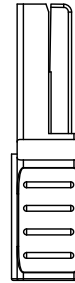
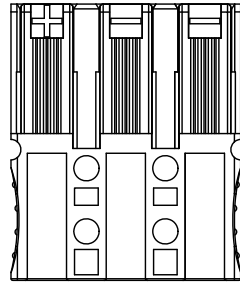
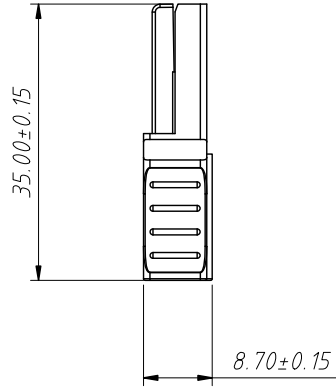
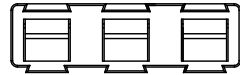

Material:  
 Housing:PC,UL 94V-0  
 Color: Red,Green,Black,White,Blue  
 Yellow,Orange,Grey,Brown  
 Pink,Purple

Electrical Characteristics:  
 Rated Current:30A  
 Rated Voltage:600V

Applicable Terminal:  
 L-KLS1-XT30-T

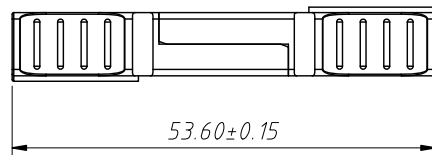
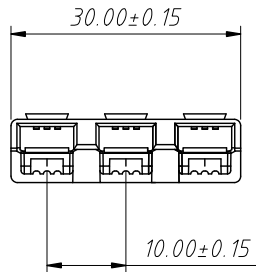

Mating Dimensions

Order Information:  
 L-KLS1-XT30D-H-R

L: RoHS  
 XT Series  
 Type:H-Housing  
 Color:  
 R-Red,G-Green,B-Black,W-White  
 L-Blue,Y-Yellow,OR-Orange  
 GY-Grey,BR-Brown,PI-Pink  
 PU-Purple

ANGLE TOLERANCE	PROJECTION	Description:	30A 600V Housing 3 Pole	
±3°				
GENERAL TOLERANCE	UNITS	mm	KLS P/N:	L-KLS1-XT30D-H-R
x.x ±0.30	SHEET SIZE	A4		
x.xx ±0.20	Draw:	Daniel	2022-04-02	
x.xxx ±0.10	Check:	Daniel	2022-04-02	
			NingBo KLS ELECTRONIC CO.,L TD.	

1  
RoHS Compliance

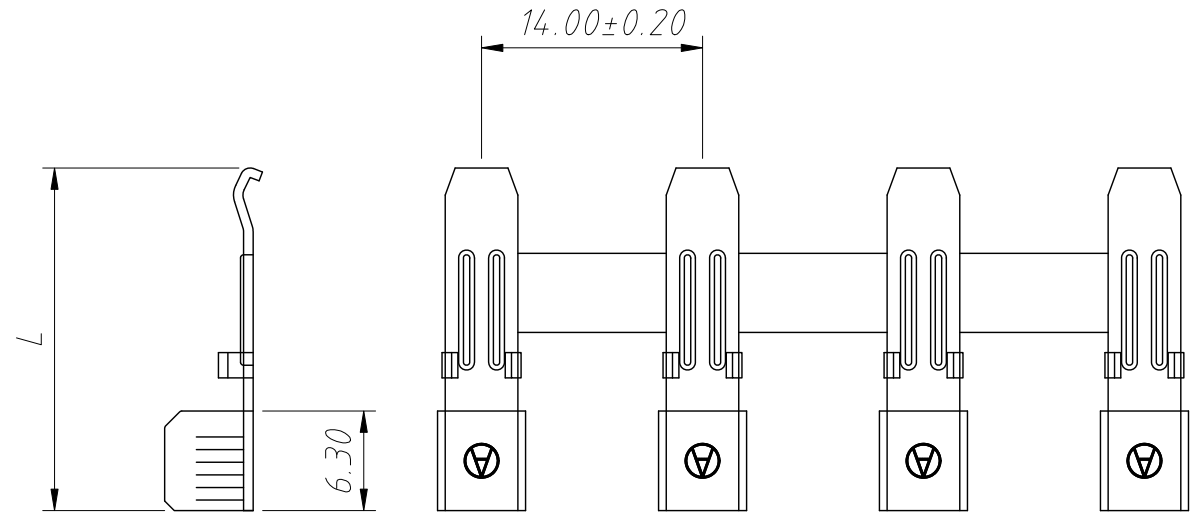

Material:  
Terminal: Red Copper, Silver Plated

Electrical Characteristics:  
Rated Current: 30A  
Rated Voltage: 600V

Applicable Housing :  
L-KLS1-XT30-H

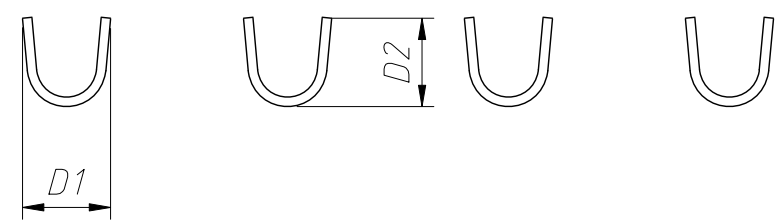

Order Information:  
L-KLS1-XT30-T  
├── L: RoHS  
├── XT Series  
└── Type: Terminal

Part Number	D1 (mm)	D2 (mm)	L (mm)	Wire
L-KLS1-XT30-T	5.57±0.50	5.6±0.50	21.7±0.20	10AWG

ANGLE TOLERANCE	PROJECTION	Description:	XT Series Terminal 30A Automobile connector
±3°			
GENERAL TOLERANCE	UNITS	mm	KLS P/N:
x.x ±0.30	SHEET SIZE	A4	L-KLS1-XT30-T
x.xx ±0.20	Draw:	Daniel	2022-04-02
x.xxx ±0.10	Check:	Daniel	2022-04-02

