

1
RoHS Compliance

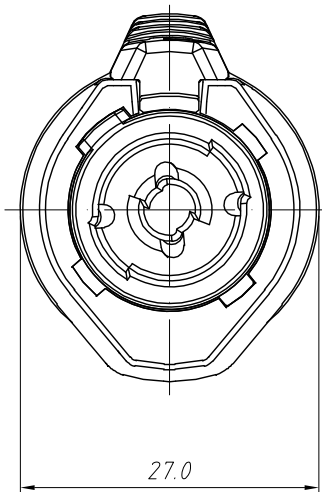

Cable OD 6.0-11.0mm

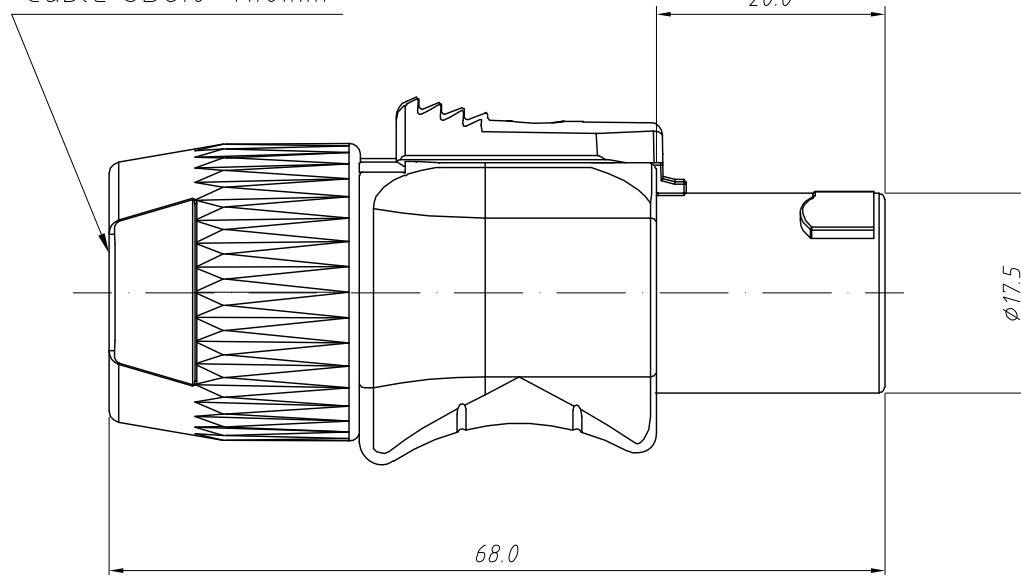

Electrical:

- 1.Voltage Rating: 250VAC
- 2.Current Rating: 15A Max.
- 3.Contact Resistance: 30mΩ Max.
- 4.Insulation Resistance: 1000MΩ Min.
- 5.Withstanding Resistance :1000VAC Min.

Mechanical:

- 1.Durability: 1000 cycles Min.
- 2.Insertion Force: 5~20N
- 3./withdrawal Force: 5~20N.

Order Information:

L-KLS1-SL P-0608-04-BL

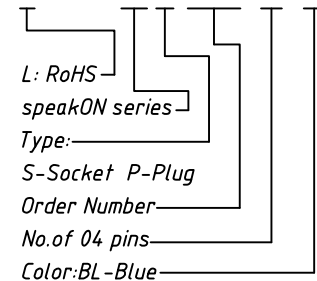

ANGLE TOLERANCE	PROJECTION	Description:	
±3°		4 pole speakON connectors Plug	
GENERAL TOLERANCE	UNITS	mm	KLS P/N:
x.x ±0.30	SHEET SIZE	A4	L-KLS1-SLP-0608-04-BL
x.xx ±0.20	Draw:	Daniel	2021-08-28
x.xxx ±0.10	Check:	Daniel	2021-08-28



NingBo KLS ELECTRONIC CO.,L TD.