

1
RoHS Compliance

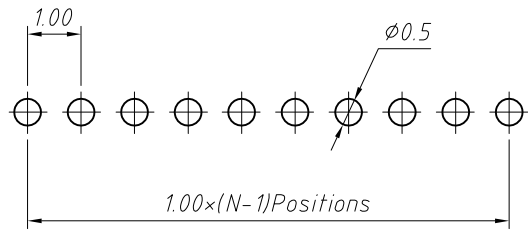

Recommended P.C.B Hole Layout

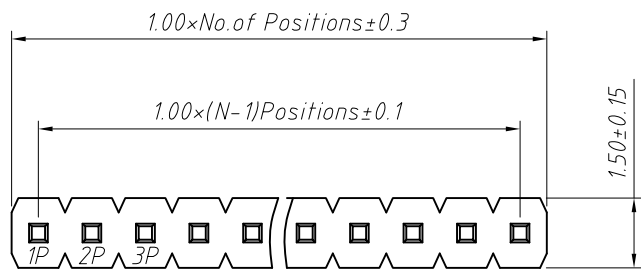
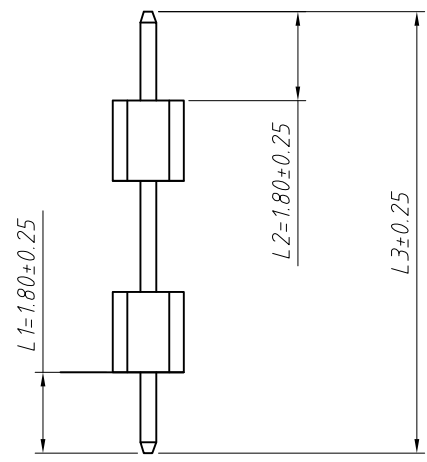
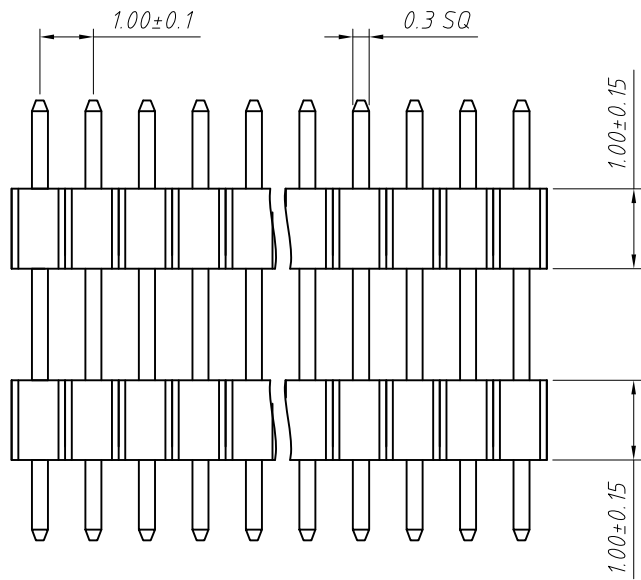

Material:
Standard: PA6T
Contact: Brass
Insulator: Polyester, UL 94 V-0

Electrical Characteristics:
Rated Current: 0.75AMP
Contact Resistance: 30mΩ Max
Withstand Voltage: 500V AC/DC
Insulator Resistance: 1000MΩ Min

Mechanical
Operating Temperature: -40°C ~ +105°C
Max. Processing Temp: 230°C for 30-60 seconds
(260°C for 10 seconds)

Order Information:
L-KLS1-218G-1.00-1-XX-S-L1xL2xL3-G0

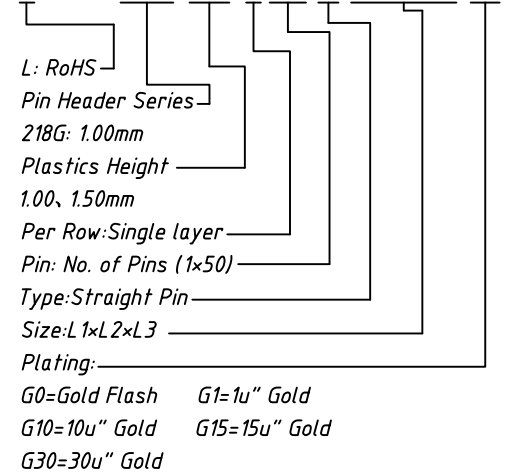

Dimension antitheses list (mm)

ITEM	L1	L2	L3	Plastic Height
Standard	1.80	1.80	---	1.00
Nonstandard	---	---	---	---

ANGLE TOLERANCE	PROJECTION	Description:	1.00mm Pin Header	
±3°			Single layer, Straight Pin, 1xN Pin	
GENERAL TOLERANCE	UNITS	mm	KLS P/N:	L-KLS1-218G-1.00-1-XX-S-L1xL2xL3-G0
x.x ±0.30	SHEET SIZE	A4		
x.xx ±0.20	Draw:	Daniel	2018-07-10	
x.xxx ±0.10	Check:	Daniel	2018-07-10	

NingBo KLS ELECTRONIC CO.,L TD.

RoHS Compliance

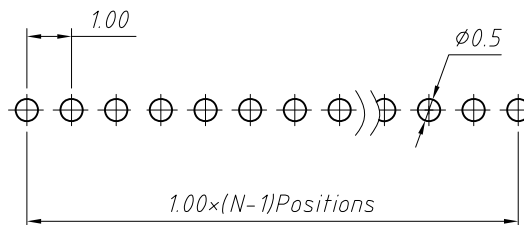
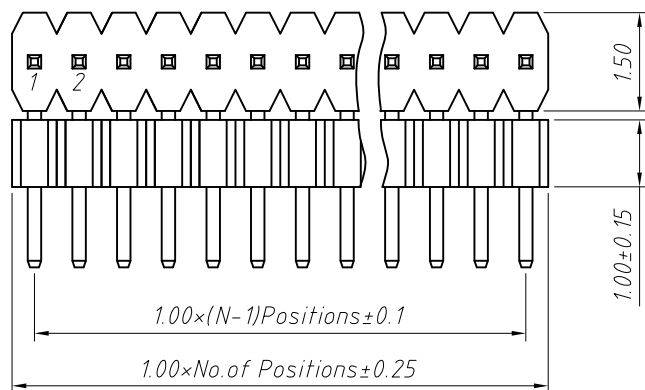

Recommended P.C.B Hole Layout

Material:
Standard: PA9T
Contact: Brass
Insulator: Polyester, UL94V-0

Electrical Characteristics:
Rated Current: 0.75AMP
Contact Resistance: 20mΩ Max
Withstand Voltage: 500V AC/DC
Insulator Resistance: 1000MΩ Min

Mechanical
Operating Temperature: -40°C ~ +105°C
Max. Processing Temp: 230°C for 30-60 seconds
(260°C for 10 seconds)

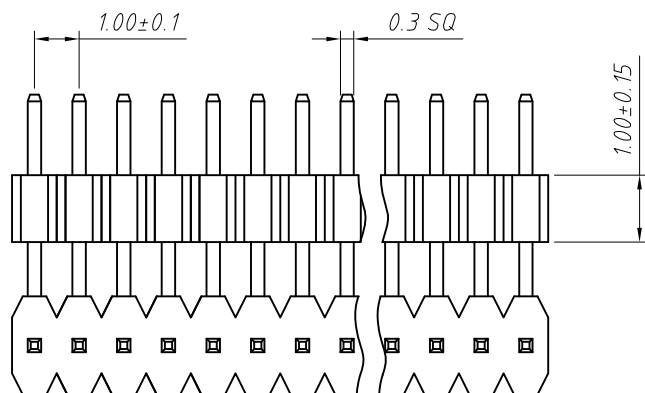

Dimension antitheses list (mm)						
ITEM	L1	L2	D	D1	D2	Plastic Height
Standard	1.80	1.80	---	---	---	1.00
Nonstandard	---	---	---	---	---	---

Order Information:
L-KLS1-218G-1.00-1-XX-R2-L1xL2xD-G0

L: RoHS
Pin Header Series
218G: 1.00mm
Plastics Height
1.00, 1.50mm
Per Row: Single layer
Pin: No. of Pins (1x50)
Right Angle Pin: R1 Type, R2 Type
Size: L1xL2xD
Plating:
G0=Gold Flash G1=1u" Gold
G10=10u" Gold G15=15u" Gold
G30=30u" Gold

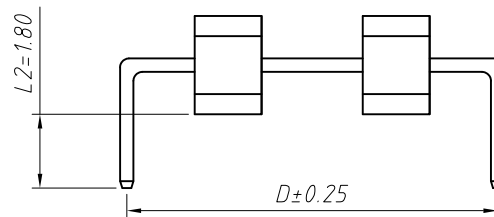

R3 Type

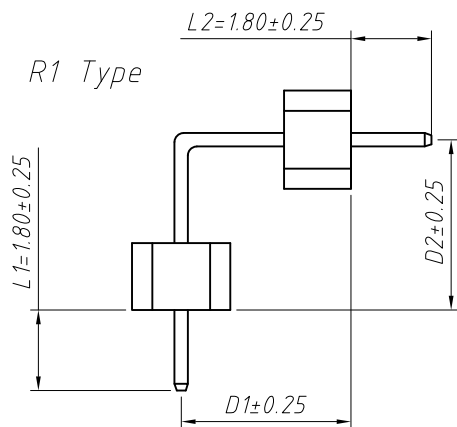

R1 Type

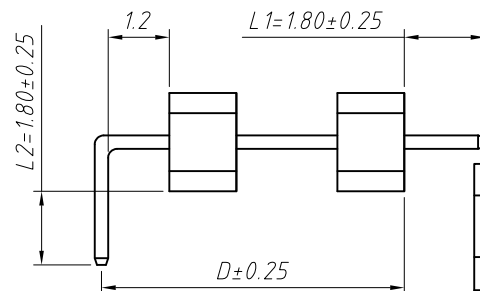

R2 Type

ANGLE TOLERANCE	PROJECTION	Description:	1.00mm Pin Header	
±3°		Single layer, Right Angle Pin, 1xN Pin		
GENERAL TOLERANCE	UNITS	mm	KLS P/N:	L-KLS1-218G-1.00-1-XX-R2-L1xL2xD-G0
x.x ±0.30	SHEET SIZE	A4		
x.xx ±0.20	Draw:	Daniel	2018-07-10	
x.xxx ±0.10	Check:	Daniel	2018-07-10	



NingBo KLS ELECTRONIC CO.,L TD.

RoHS Compliance

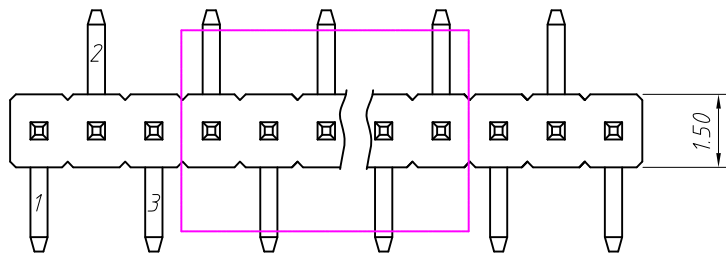

T2 Type

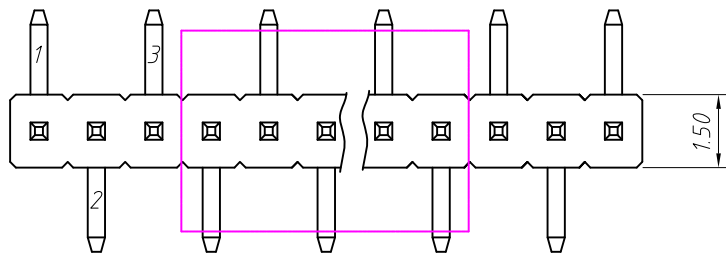

T1 Type

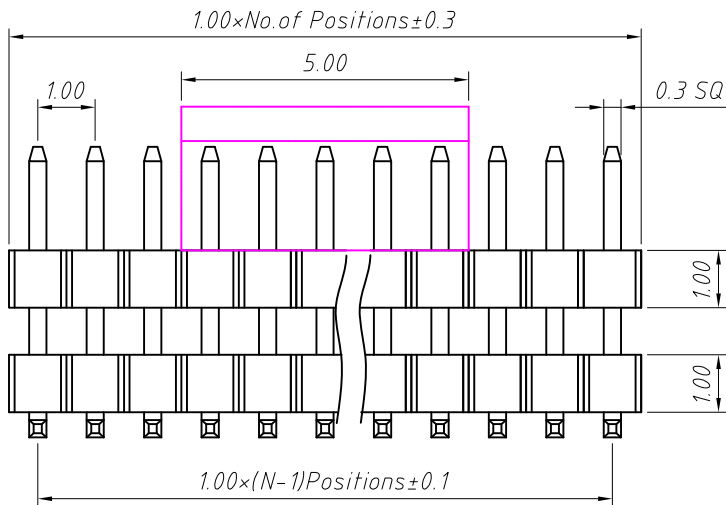

Recommended P.C.B Hole Layout

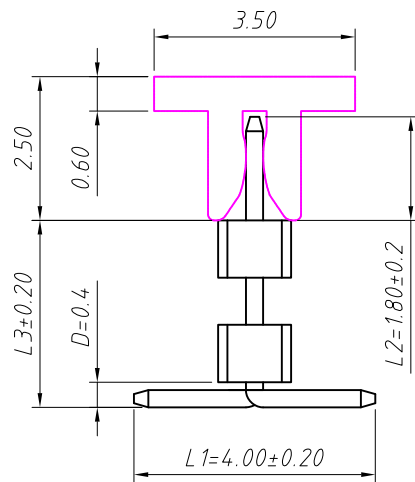
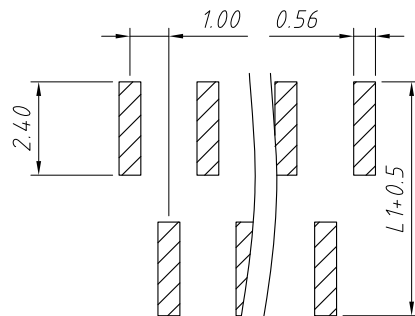
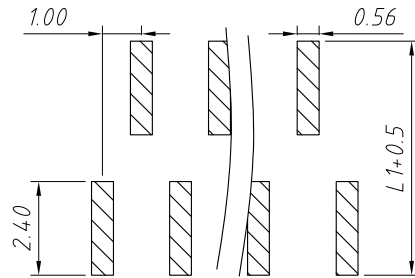

Material:
Standard: PA9T
Contact: Brass
Insulator: Polyester, UL94V-0

Electrical Characteristics:
Rated Current: 0.75AMP
Contact Resistance: 20mΩ Max
Withstand Voltage: 500V AC/DC
Insulator Resistance: 1000MΩ Min

Mechanical
Operating Temperature: -40°C ~ +105°C
Max. Processing Temp: 230°C for 30-60 seconds
(260°C for 10 seconds)

Order Information:

L-KLS1-218G-1.00-1-XX-T1-L1xL2xL3xD-G0-N-R

L: RoHS
Pin Header Series
218G: 1.00mm
Plastics Height
1.00, 1.50mm
Per Row: Single layer
Pin: No. of Pins (1x50)
SMT Pin: T1 Type, T2 Type
Size: L1xL2xL3xD
Plating:
G0=Gold Flash G1=1u" Gold
G10=10u" Gold G15=15u" Gold G30=30u" Gold
Post: W=With Post N=W/O Post
Packing:
0=PE Bag A=Tray T=Tube
P=Tube+Cap R=Reel+Cap

Dimension antitheses list (mm)

ITEM	L1	L2	L3	D	Plastic Height
Standard	4.00	1.80	---	0.4	1.00
Nonstandard	---	---	---	---	---

ANGLE TOLERANCE	PROJECTION	Description:	1.00mm Pin Header	
±3°			Single layer, SMT Pin, 1xN Pin	
GENERAL TOLERANCE	UNITS	mm	KLS P/N:	L-KLS1-218G-1.00-1-XX-T1-L1xL2xDxW-G0
x.x ±0.30	SHEET SIZE	A4		
x.xx ±0.20	Draw:	Daniel	2018-07-10	
x.xxx ±0.10	Check:	Daniel	2018-07-10	

NingBo KLS ELECTRONIC CO.,LTD.

RoHS Compliance

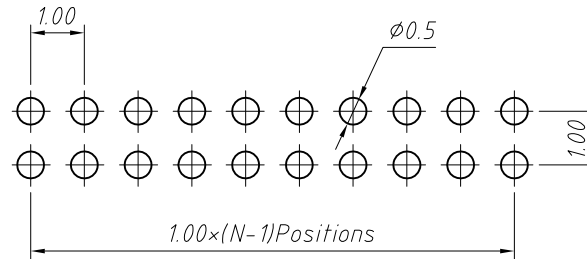
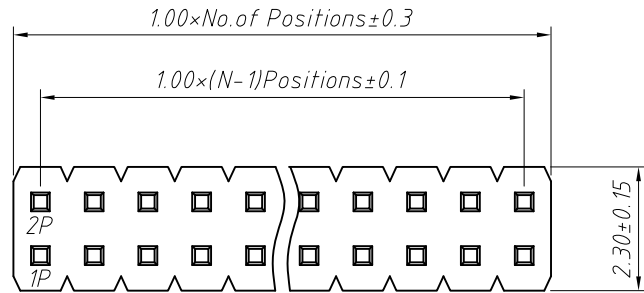

Recommended P.C.B Hole Layout

Material:
Standard: PA6T
Contact: Brass
Insulator: Polyester, UL94V-0

Electrical Characteristics:
Rated Current: 0.75AMP
Contact Resistance: 30mΩ Max
Withstand Voltage: 500V AC/DC
Insulator Resistance: 1000MΩ Min

Mechanical
Operating Temperature: -40°C ~ +105°C
Max. Processing Temp: 230°C for 30-60 seconds
(260°C for 10 seconds)

Order Information:

L-KLS1-218G-1.00-2-XX-S-L1xL2xL3-G0

L: RoHS
Pin Header Series
218G: 1.00mm
Plastics Height
1.00, 1.50mm
Per Row: Double layer
Pin: No. of Pins (02~100)
Type: Straight Pin
Size: L1xL2xL3
Plating:
G0=Gold Flash G1=1u" Gold
G10=10u" Gold G15=15u" Gold
G30=30u" Gold

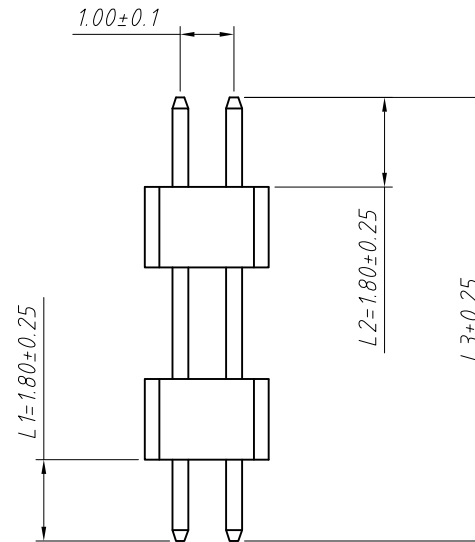
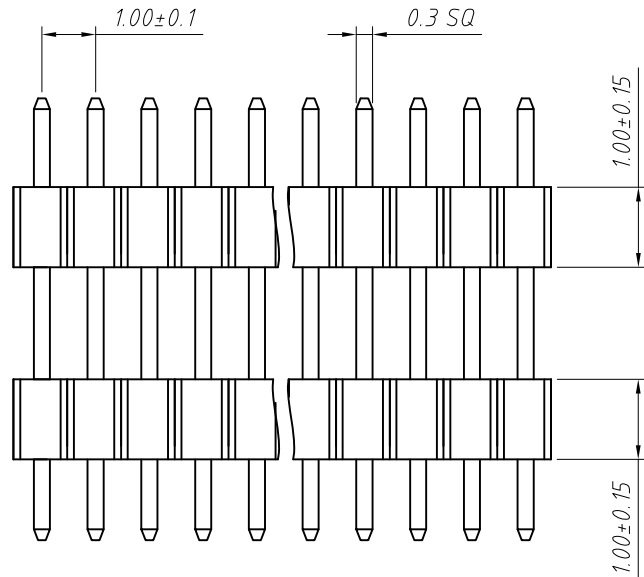

Dimension antitheses list (mm)

ITEM	L1	L2	L3	Plastic Height
Standard	1.80	1.80	---	1.00
Nonstandard	---	---	---	---

ANGLE TOLERANCE	PROJECTION	Description:	1.00mm Pin Header	
±3°		Double layer, Straight Pin, 2xN Pin		
GENERAL TOLERANCE	UNITS	mm	KLS P/N:	L-KLS1-218G-1.00-2-XX-S-L1xL2xL3-G0
x.x ±0.30	SHEET SIZE	A4		
x.xx ±0.20	Draw:	Daniel	2018-07-10	
x.xxx ±0.10	Check:	Daniel	2018-07-10	



NingBo KLS ELECTRONIC CO.,LTD.

RoHS Compliance

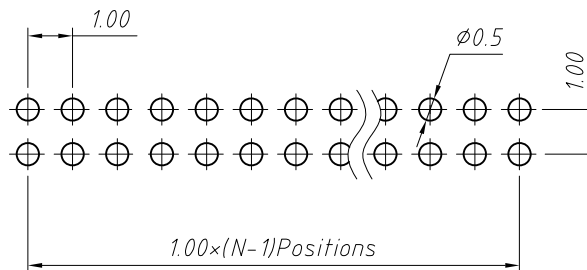
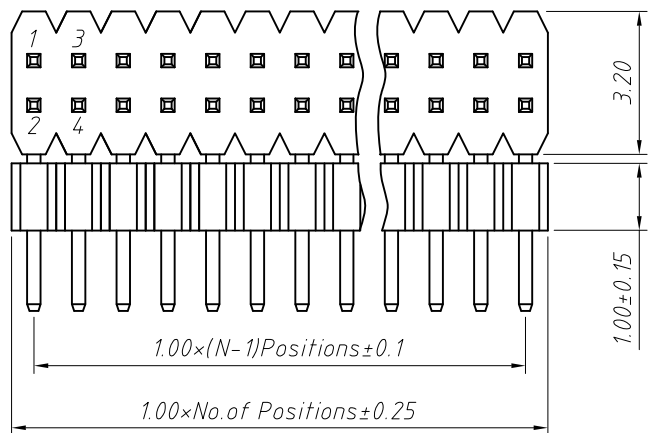

Recommended P.C.B Hole Layout

Material:
 Standard: PA9T
 Contact: Brass
 Insulator: Polyester, UL94V-0

Electrical Characteristics:
 Rated Current: 0.75AMP
 Contact Resistance: $20m\Omega$ Max
 Withstand Voltage: 500V AC/DC
 Insulator Resistance: $1000M\Omega$ Min

Mechanical
 Operating Temperature: $-40^{\circ}\text{C} \sim +105^{\circ}\text{C}$
 Max. Processing Temp: 230°C for 30-60 seconds
 (260°C for 10 seconds)

Order Information:

L-KLS1-218G-1.00-2-XX-R2-L1xL2xD-G0

L: RoHS
 Pin Header Series
 218G: 1.00mm
 Plastics Height
 1.00, 1.50mm
 Per Row: Double layer
 Pin: No. of Pins (02~100)
 Right Angle Pin: R1 Type, R2 Type
 Size: L1xL2xD
 Plating:
 G0=Gold Flash G1=1u" Gold
 G10=10u" Gold G15=15u" Gold
 G30=30u" Gold

Dimension antitheses list (mm)						
ITEM	L1	L2	D	D1	D2	Plastic Height
Standard	1.80	1.80	---	---	---	1.00
Nonstandard	---	---	---	---	---	---

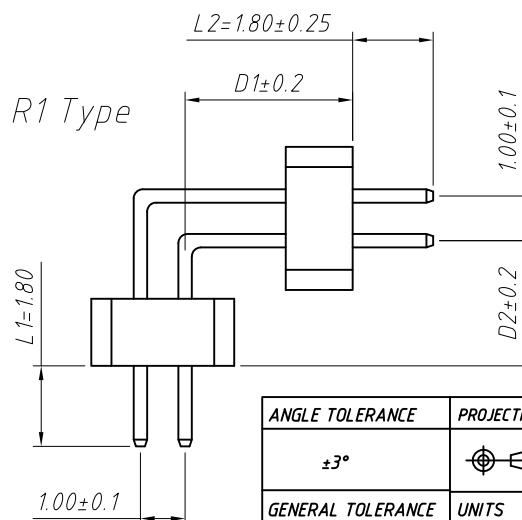
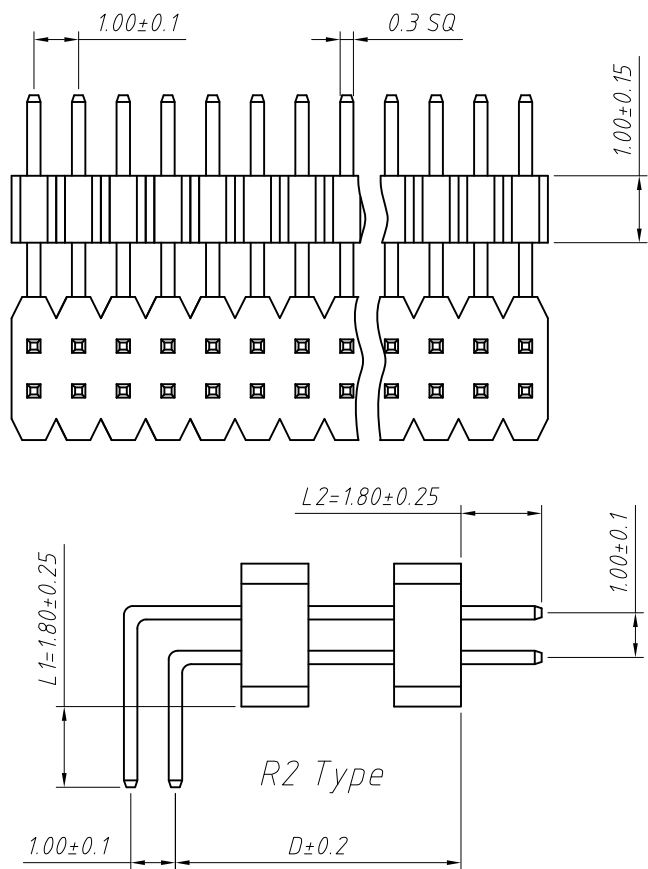

ANGLE TOLERANCE	PROJECTION	Description:	1.00mm Pin Header	
$\pm 3^{\circ}$		Double layer, Right Angle Pin, 2xN Pin		
GENERAL TOLERANCE	UNITS	mm	KLS P/N:	L-KLS1-218G-1.00-2-XX-R2-L1xL2xD-G0
x.x ± 0.30	SHEET SIZE	A4		
x.xx ± 0.20	Draw:	Daniel	2018-07-10	
x.xxx ± 0.10	Check:	Daniel	2018-07-10	

KLS NingBo KLS ELECTRONIC CO.,L TD.

RoHS Compliance

Recommended P.C.B Hole Layout

Material:
Standard:PA9T
Contact: Brass
Insulator:Polyester,UL94V-0

Electrical Characteristics:
Rated Current: 0.75AMP
Contact Resistance: 20mΩ Max
Withstand Voltage: 500V AC/DC
Insulator Resistance: 1000MΩ Min

Mechanical
Operating Temperature: -40°C~+105°C
Max.Processing Temp:230°C for 30-60 seconds
(260°C for 10 seconds)

Order Information:

L-KLS1-218G-1.00-2-XX-L1xL2xL3xD-G0-W-R

L: RoHS
Pin Header Series
218G: 1.00mm
Plastics Height
1.00, 1.50mm
Per Row:Double layer
Pin: No. of Pins (02~100)
Size:L1xL2xL3xD
Plating:
G0=Gold Flash G1=1u" Gold
G10=10u" Gold G15=15u" Gold G30=30u" Gold
Post:W=With Post N=W/O Post
Packing:
0=PE Bag A=Tray T=Tube
P=Tube+Cap R=Reel+Cap

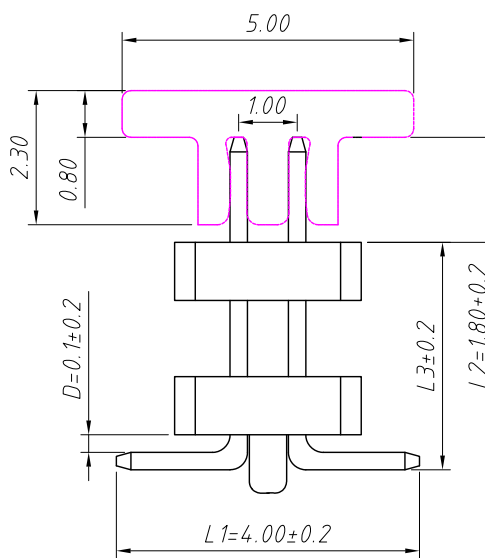
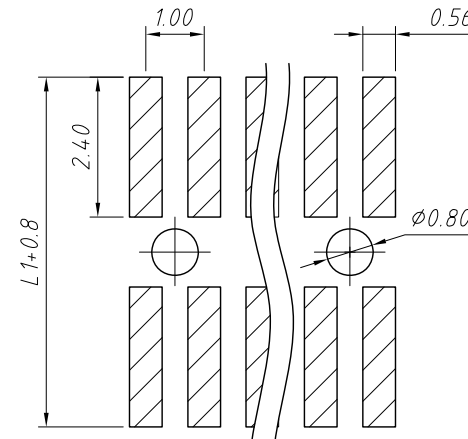

W=With Post

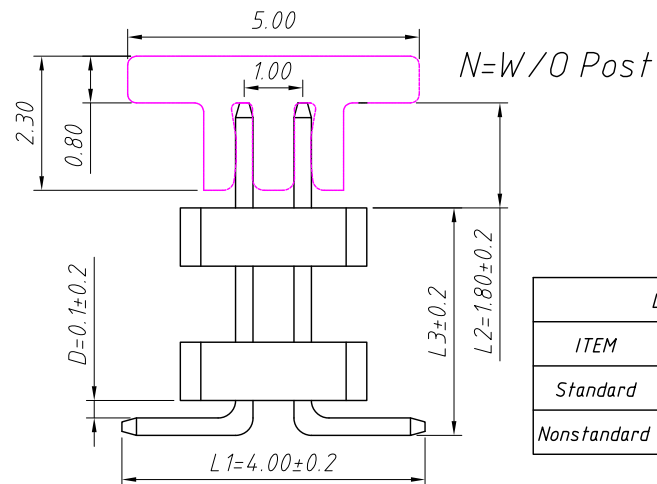
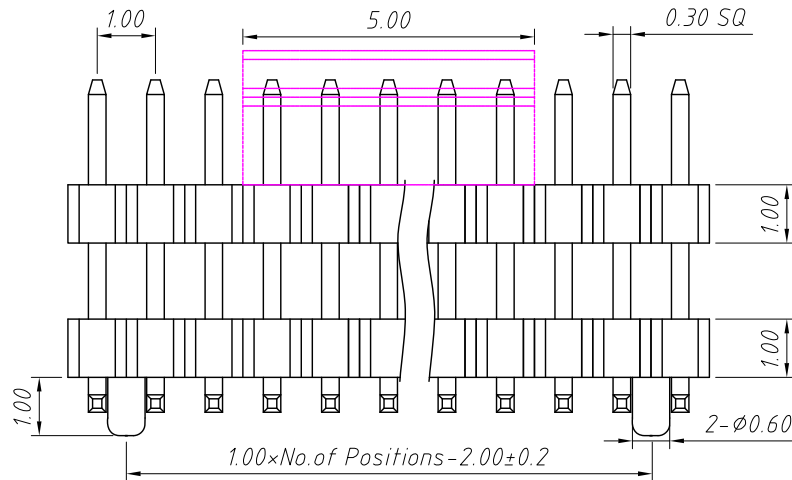
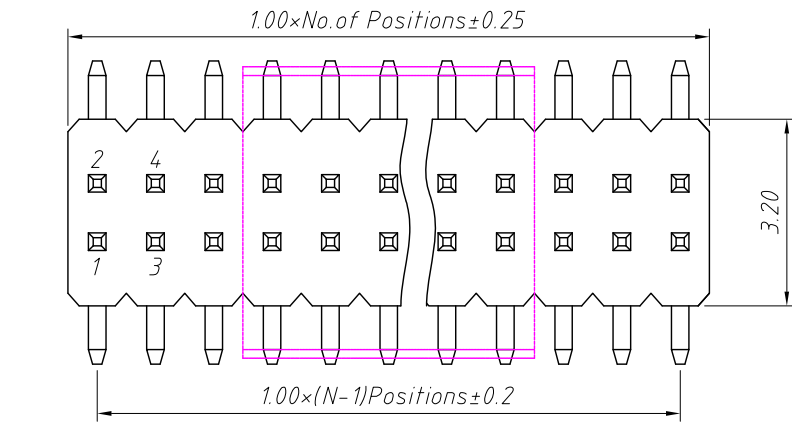

Dimension antitheses list (mm)					
ITEM	L1	L2	L3	D	Plastic Height
Standard	4.00	1.80	---	0.1	1.00
Nonstandard	---	---	---	---	---

ANGLE TOLERANCE	PROJECTION	Description:	1.00mm Pin Header	
±3°			Double layer, SMT Pin, 2xN Pin	
GENERAL TOLERANCE	UNITS	mm	KLS P/N:	L-KLS1-218G-1.00-2-XX-L1xL2xL3xD-G0-W-R
x.x ±0.30	SHEET SIZE	A4		
x.xx ±0.20	Draw:	Daniel	2018-07-10	
x.xxx ±0.10	Check:	Daniel	2018-07-10	



NingBo KLS ELECTRONIC CO.,L.TD.