

Proper Cable

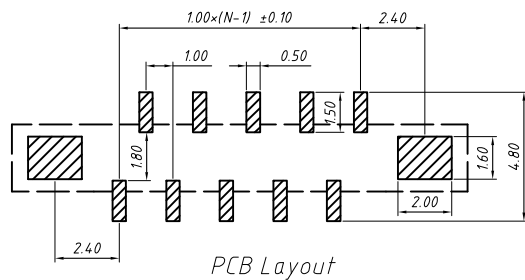

PCB Layout

Material
 Housing:LCP, UL94V-0
 Lock:LCP, UL94V-0
 Plug spring:Phosphor Bronze,Gold/Tin
 Soldering:Phosphor Bronze,Gold/Tin

Electrical
 Voltage rating: 50 V
 Current Rating: 0.5 A
 Withstanding Voltage: 500 V
 Insulation resistance: 800MΩ.Min.
 Contact resistance: 20 mΩ.Max.

Mechanical
 Temp. Range: -25 °C ~ +85 °C

Order Information

L-KLS1- 1240D - 5.5- XX -T-P-R

RoHS
 Series No.
 No. of pins(04 ~ 30 pins)
 Vertical SMT Pin
 Positive needle
 Packing: T-Tube R-Reel

GENERAL TOLERANCE	ANGLE TOLERANCE	PROJECTION	Description:
X. ±0.30	X. ±5°	UNITS	CONN FFC 1.00mm,Positive needle,SMD,Vertical,with ZIF
.X ±0.25	.X ±2°	SHEET SIZE	
.XX ±0.20	.XX ±1°	KLS P/N:	

Draw by: Date	2021-04-14
Check by: Date	2021-04-14
SCALE	SHEET OF

KLS
 NingBo KLS ELECTRONIC CO.,LTD.

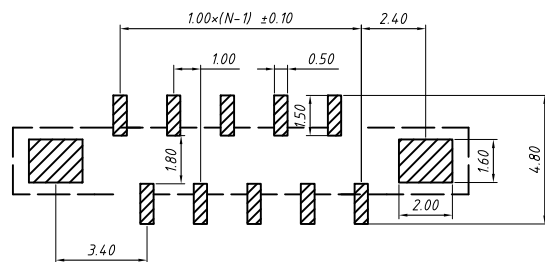
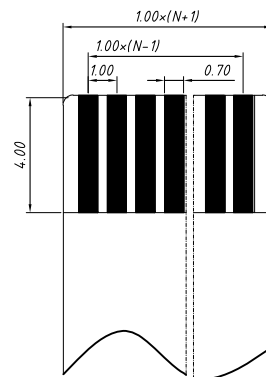
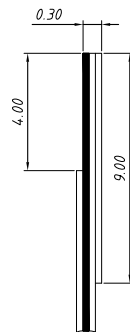
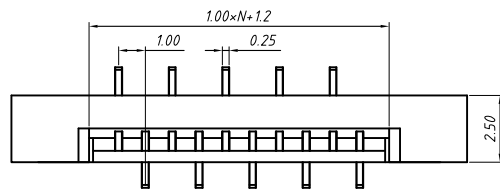
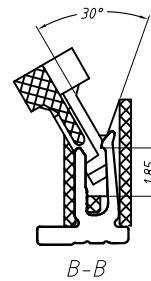
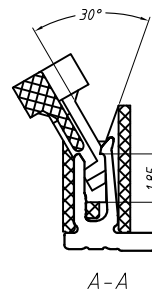
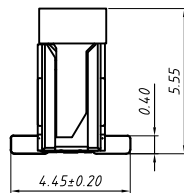
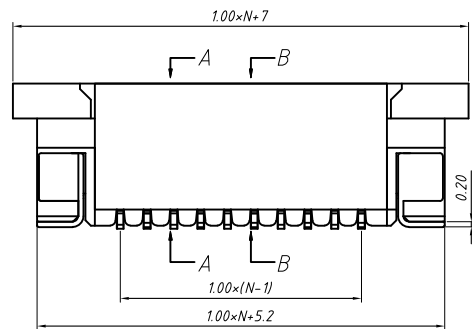

PCB layout

Proper Cable

Material
Housing:LCP, UL94V-0
Lock:LCP, UL94V-0
Plug spring:Phosphor Bronze,Gold/Tin
Soldering:Phosphor Bronze,Gold/Tin

Electrical
Voltage rating: 50 V
Current Rating: 0.5 A
Withstanding Voltage: 500 V
Insulation resistance: 800MΩ.Min.
Contact resistance: 20 mΩ.Max.

Mechanical
Temp. Range: -25 °C ~ + 85 °C

Order Information

L-KLS1- 1240D - 5.5- XX -T-A-R

RoHS
Series No.
No.of pins(04 ~ 30 pins)
Vertical SMT Pin
Anti-needle
Packing: T-Tube R-Reel

GENERAL TOLERANCE	ANGLE TOLERANCE	PROJECTION	Description:
.X ±0.30	.X ±5°	UNITS	CONN FFC 1.00mm, Anti-needle, SMD, Vertical, with ZIF
.X ±0.25	.X ±2°	SHEET SIZE	
.XX ±0.20	.XX ±1°	KLS P/N:	

Draw by: Date	2018-03-10
Check by: Date	2018-03-10
SCALE	SHEET OF



NingBo KLS ELECTRONIC CO.,LTD.