

1
RoHS Compliance

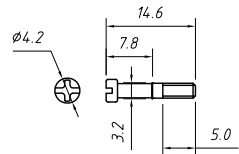
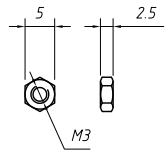
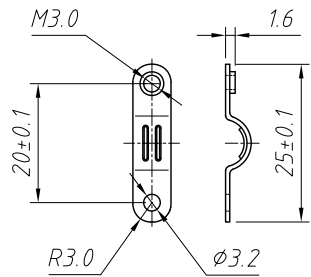

Short screw

Order Information:

L-KLS1-DBJ-09P-S-G

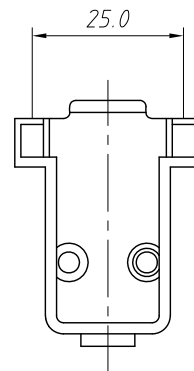
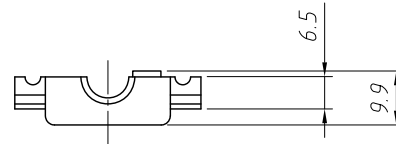
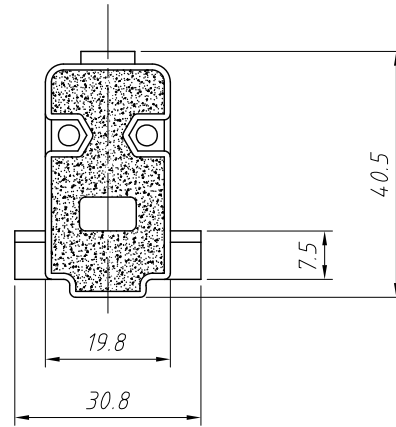
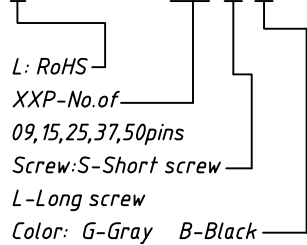

Cover Material: Chromium plated
Screw Material: STEEL

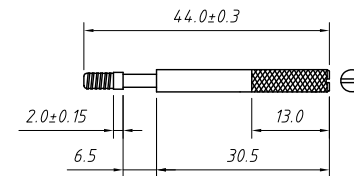
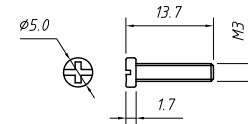
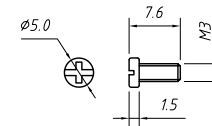
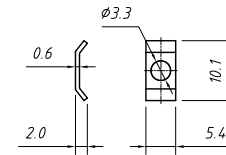

Long screw

ANGLE TOLERANCE	PROJECTION	Description:	
±3°		D-SUB HOOD PLASTIC MATERIAL (09-37Pin)	
GENERAL TOLERANCE	UNITS	mm	KLS P/N:
x.x ±0.30	SHEET SIZE	A4	L-KLS1-DBJ-09P-S-G
x.xx ±0.20	Draw:	Daniel	2020-11-11
x.xxx ±0.10	Check:	Daniel	2020-11-11



NingBo KLS ELECTRONIC CO.,LTD.

1
RoHS Compliance

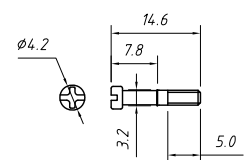
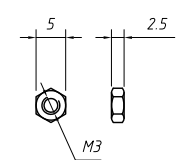
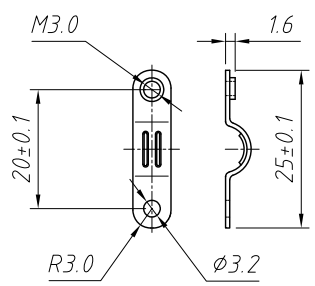

Short screw

Order Information:

L-KLS1-DBJ-15P-S-G

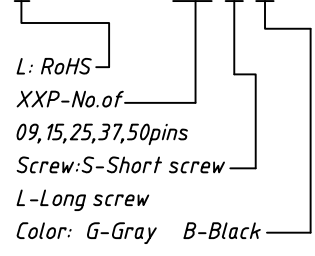

L: RoHS
XXP-No.of
09,15,25,37,50pins
Screw:S-Short screw
L-Long screw
Color: G-Gray B-Black

Cover Material: Chromium plated
Screw Material: STEEL

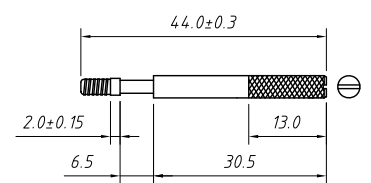
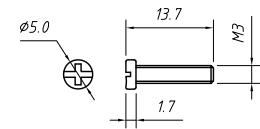
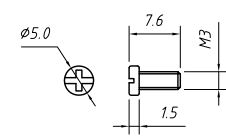
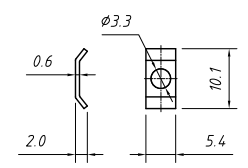
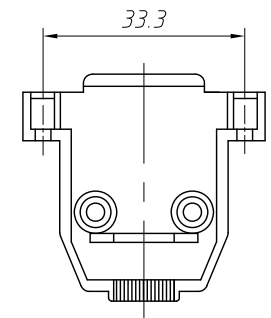
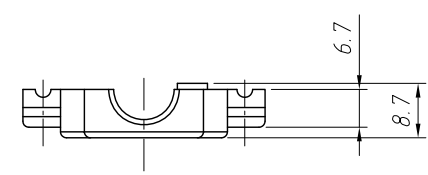
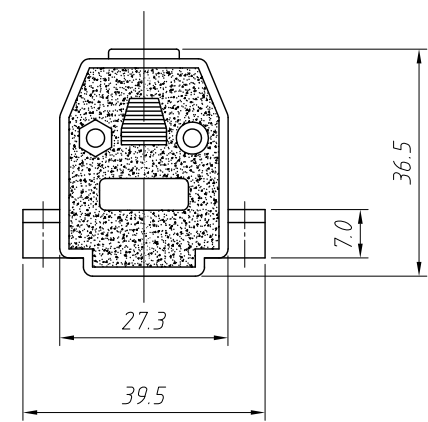

Long screw

ANGLE TOLERANCE	PROJECTION	Description:	
±3°		D-SUB HOOD PLASTIC MATERIAL (09-37Pin)	
GENERAL TOLERANCE	UNITS	mm	KLS P/N:
x.x ±0.30	SHEET SIZE	A4	L-KLS1-DBJ-15P-S-G
x.xx ±0.20	Draw:	Daniel	2020-11-11
x.xxx ±0.10	Check:	Daniel	2020-11-11



NingBo KLS ELECTRONIC CO.,LTD.

1
RoHS Compliance

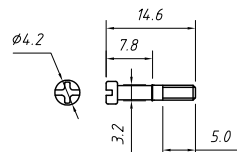
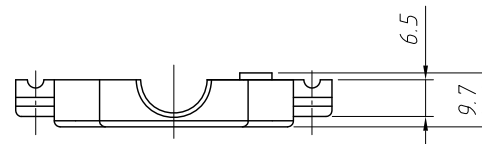
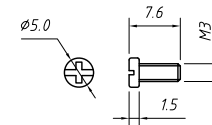
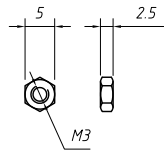
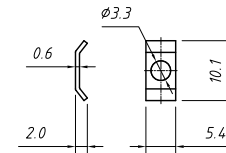
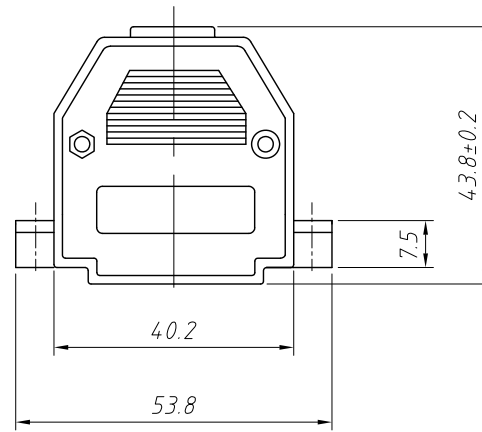
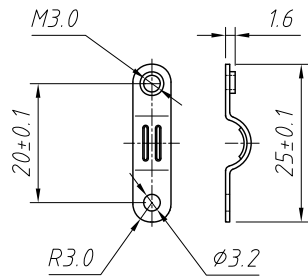

Short screw

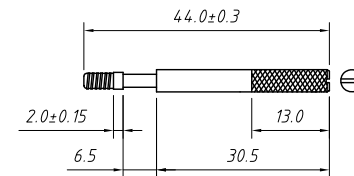
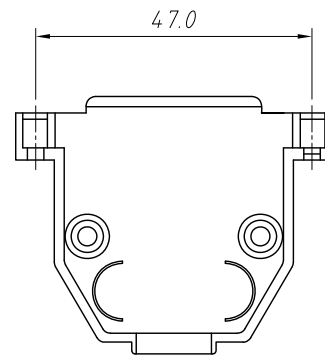
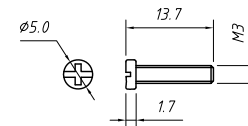

Long screw

Order Information:

L-KLS1-DBJ-25P-S-G

L: RoHS

XXP-No.of

09,15,25,37,50pins

Screw:S-Short screw

L-Long screw

Color: G-Gray B-Black

Cover Material:Chromium plated
Screw Material: STEEL

ANGLE TOLERANCE	PROJECTION	Description:	
±3°		D-SUB HOOD PLASTIC MATERIAL (09-37Pin)	
GENERAL TOLERANCE	UNITS	mm	KLS P/N:
x.x ±0.30	SHEET SIZE	A4	L-KLS1-DBJ-25P-S-G
x.xx ±0.20	Draw:	Daniel	2020-11-11
x.xxx ±0.10	Check:	Daniel	2020-11-11



NingBo KLS ELECTRONIC CO.,L TD.

1
RoHS Compliance

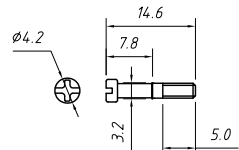
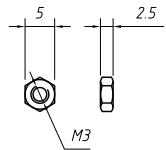
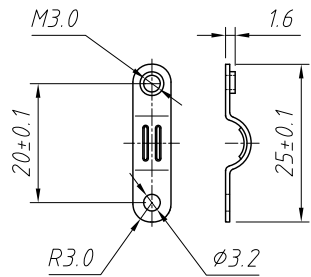

Short screw

Order Information:

L-KLS1-DBJ-37P-S-G

L: RoHS

XXP-No.of

09,15,25,37,50pins

Screw:S-Short screw

L-Long screw

Color: G-Gray B-Black

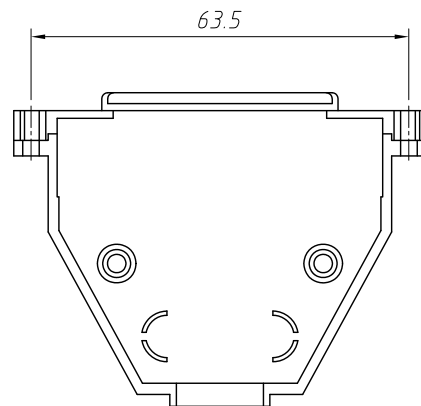
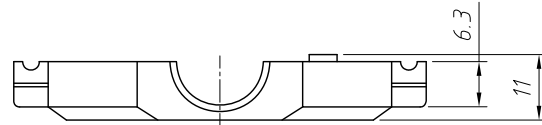
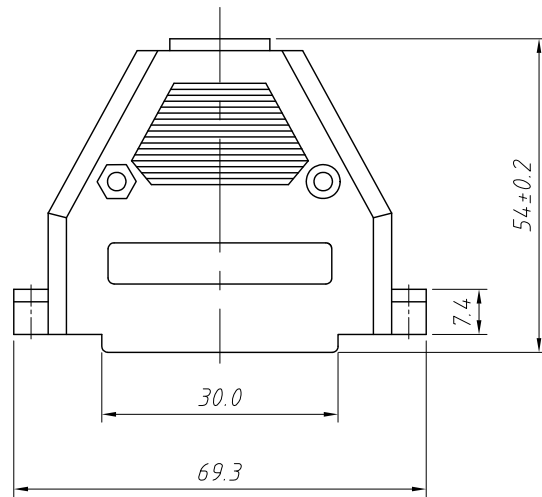

Cover Material:Chromium plated
Screw Material: STEEL

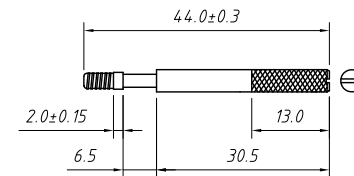
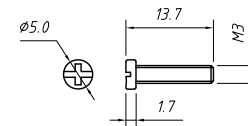
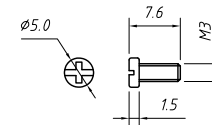
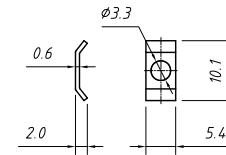

Long screw

ANGLE TOLERANCE		PROJECTION		Description:	
±3°				D-SUB HOOD PLASTIC MATERIAL (09-37Pin)	
GENERAL TOLERANCE		UNITS	mm	KLS P/N:	L-KLS1-DBJ-37P-S-G
x.x	±0.30	SHEET SIZE	A4		
x.xx	±0.20	Draw:	Daniel	2020-11-11	
x.xxx	±0.10	Check:	Daniel	2020-11-11	



NingBo KLS ELECTRONIC CO.,L TD.