

RoHS Compliant

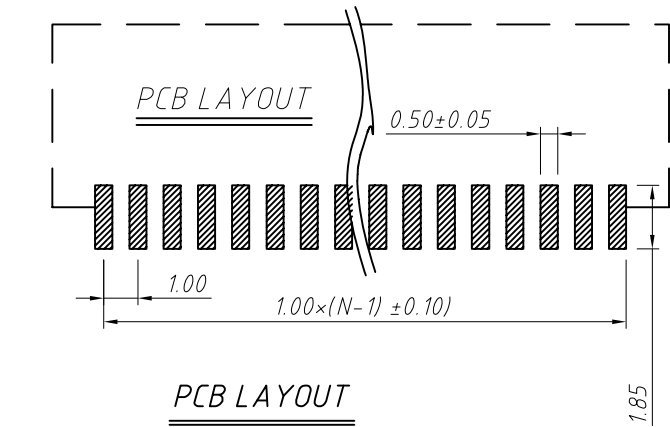
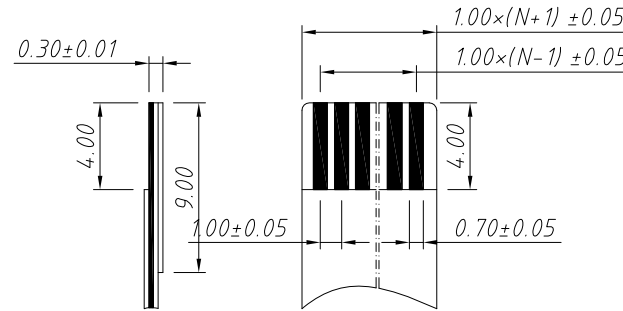
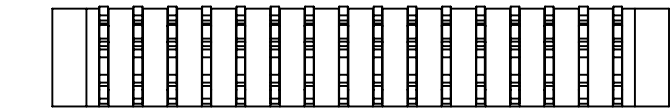
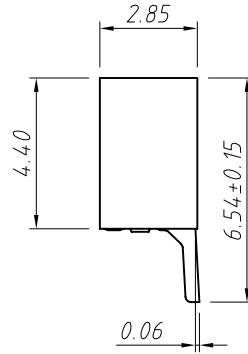
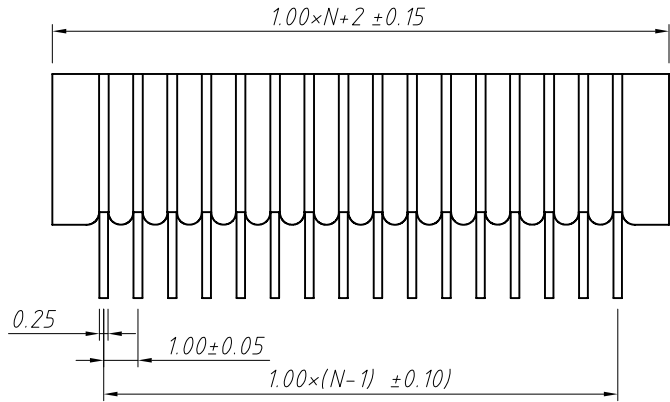
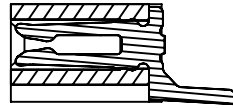
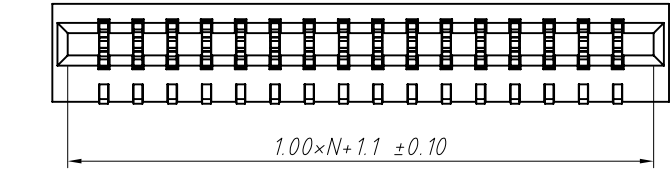

Proper Cable

Material
 Housing: LCP, UL 94V-0
 Contact: Phosphor Bronze, Tin plated

Electrical
 Voltage rating: 50 V
 Current rating: 0.5 A
 Withstand Voltage: 500 V
 Insulation resistance: 500MΩ.Min.
 Contact resistance: 30 mΩ.max.

Mechanical
 Temp. Range: -25 °C ~ + 85 °C

Order Information
 L-KLS1- 240C - XX -RT-R

RoHS
 Series No.
 No. of pins (04 ~ 35 pins)
 RT- SMD, Horizontal
 Packing: T-Tube R-Reel

GENERAL TOLERANCE		ANGLE TOLERANCE		PROJECTION		Description:	
X	±0.15	X	±5°	UNITS	mm	CONN FFC 1.00mm, SMD, Horizontal	
.X	±0.03	.X	±3°	SHEET SIZE	A4		
.XX	±0.05	.XX	±2°	KLS P/N:			
Draw by: Date				2018-03-10		L-KLS1-240C-XX-RT-R	
Check by: Date				2018-03-10			
SCALE				SHEET OF			

KLS NingBo KLS ELECTRONIC CO.,LTD.

1 2 3 4 5 6 7 8

A

B

C

D

E

F

G

H

A

B

C

D

E

F

G

H

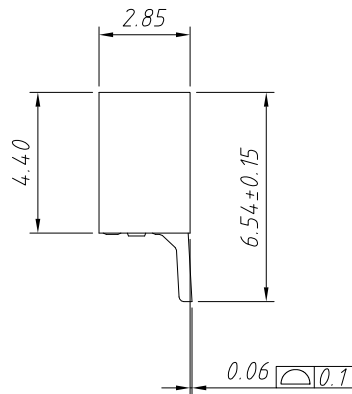
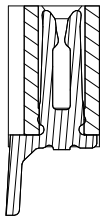
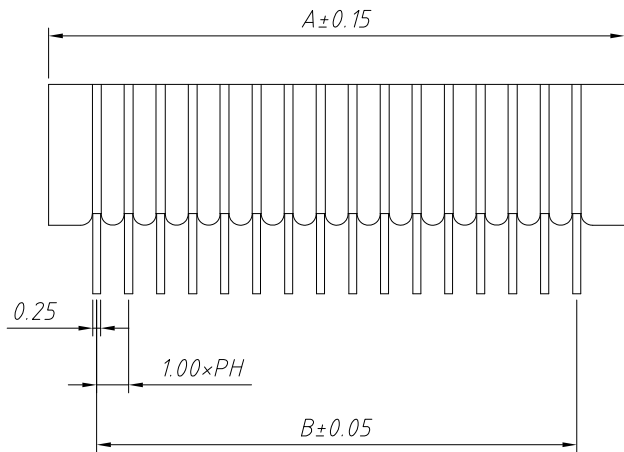
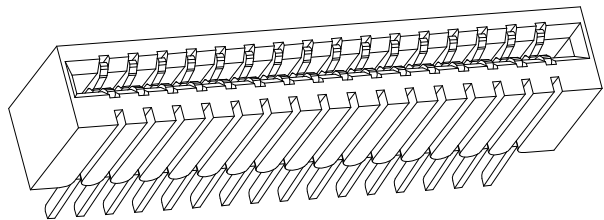
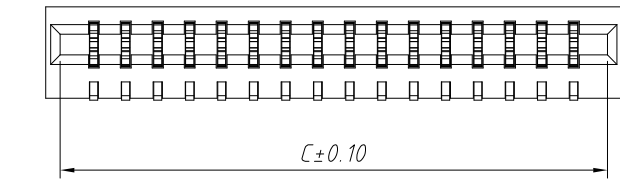

Material
 Housing: LCP UL 94V-0
 Plug spring: Phosphor Bronze, Gold/Tin
Electrical
 Voltage rating: 50 V
 Current rating: 0.5 A
 Withstanding Voltage: 500 V
 Insulation resistance: 800MΩ.Min.
 Contact resistance: 20 mΩ.max.
 Temp. Range: -20 °C ~ +85 °C

Pins	A	B	C
04	6.00	3.00	5.10
05	7.00	4.00	6.10
06	8.00	5.00	7.10
07	9.00	6.00	8.10
08	10.00	7.00	9.10
09	11.00	8.00	10.10
10	12.00	9.00	11.10
11	13.00	10.00	12.10
12	14.00	11.00	13.10
13	15.00	12.00	14.10
14	16.00	13.00	15.10
15	17.00	14.00	16.10
16	18.00	15.00	17.10
17	19.00	16.00	18.10
18	20.00	17.00	19.10
19	21.00	18.00	20.10
20	22.00	19.00	21.10
21	23.00	20.00	22.10
22	24.00	21.00	23.10
23	25.00	22.00	24.10
24	26.00	23.00	25.10
25	27.00	24.00	26.10
26	28.00	25.00	27.10
27	29.00	26.00	28.10
28	30.00	27.00	29.10
29	31.00	28.00	30.10
30	32.00	29.00	31.10
31	33.00	30.00	32.10
32	34.00	31.00	33.10
33	35.00	32.00	34.10
34	36.00	33.00	35.10
35	37.00	34.00	36.10

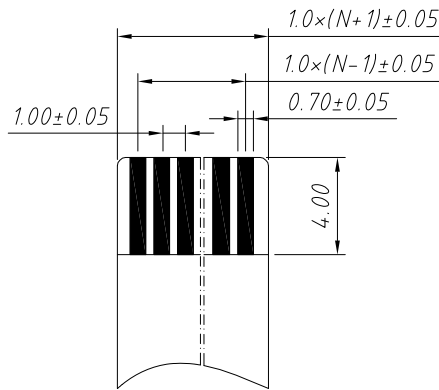
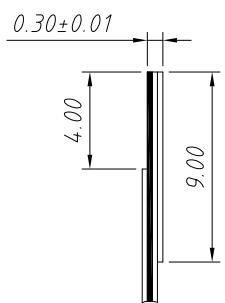
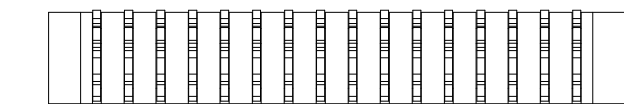

Suitable for flat cables

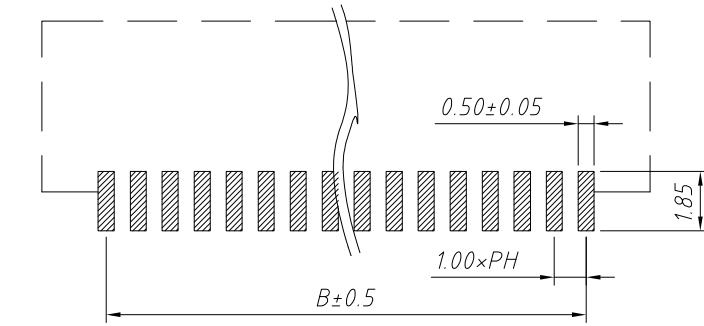

PCB LAYOUT

GENERAL TOLERANCE	PROJECTION		Description:
X. ±0.30	UNITS	mm	CONN FFC 1.00mm, SMD Horizontal type
.X ±0.25	SCALE	1:1	
.XX ±0.20	Draw by:	Jenny	
ANGLE TOLERANCE	Check by:		KLS P/N: L-KLS1-240I-2.85-24-R
X. ±5°	Date	2018-03-01	NingBo KLS ELECTRONIC CO.,L TD.
.X ±2°	SHEET	1 OF 1	
.XX ±1°			

1 2 3 4 5 6 7 8