

**Material**  
Housing: PA9T, UL94V-0  
Terminal: Phosphor Bronze

**Electrical**  
Voltage rating: 50 V  
Current Rating: 0.4 A  
Withstanding Voltage: 200 V  
Insulation resistance: 500M $\Omega$ .Min.  
Contact resistance: 20 m $\Omega$ .Max.

**Mechanical**  
Temp. Range: -25 °C ~ +85 °C

**Order Information**

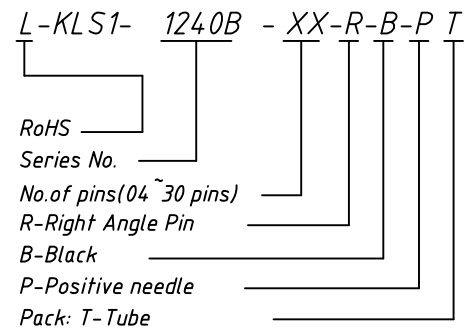

GENERAL TOLERANCE	ANGLE TOLERANCE	PROJECTION	Description:
X. $\pm 0.15$	X. $\pm 5^\circ$	UNITS	1.00mm Pitch FFC/FPC Connector
.X $\pm 0.03$	.X $\pm 3^\circ$	SHEET SIZE	
.XX $\pm 0.05$	.XX $\pm 2^\circ$	KLS P/N:	
Draw by: Date		2018-03-10	
Check by: Date		2018-03-10	
SCALE	SHEET	OF	L-KLS1-1240B-XX-R-B-PT

**KLS** NingBo KLS ELECTRONIC CO.,LTD.

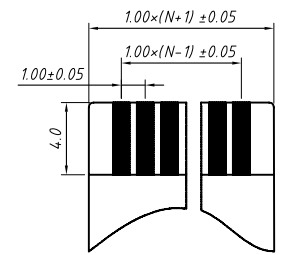
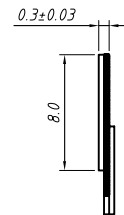
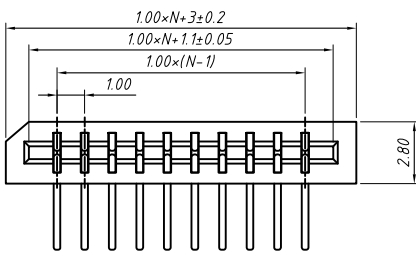

Proper Cable

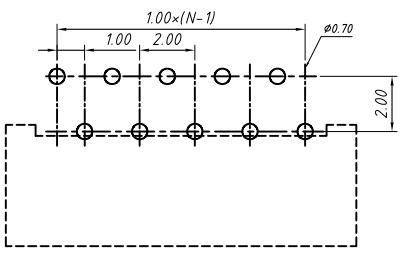
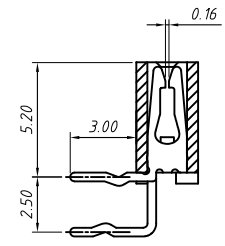
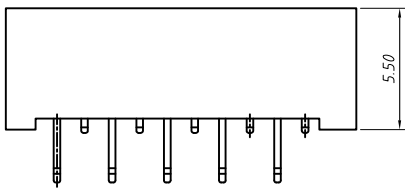

PCB Layout

**Material**  
Housing: PA9T, UL94V-0  
Terminal: Phosphor Bronze

**Electrical**  
Voltage rating: 50 V  
Current Rating: 0.4 A  
Withstanding Voltage: 200 V  
Insulation resistance: 500M $\Omega$ .Min.  
Contact resistance: 20 m $\Omega$ .Max.

**Mechanical**  
Temp. Range: -25 °C ~ +85 °C

**Order Information**

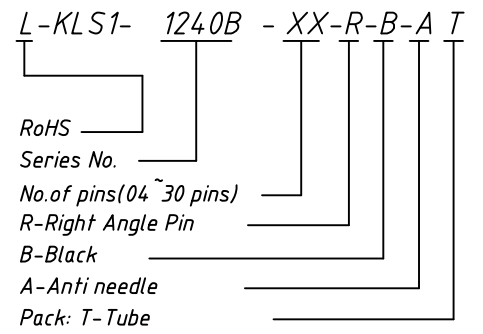

GENERAL TOLERANCE	ANGLE TOLERANCE	PROJECTION	Description:
X. ±0.15	X. ±5°	UNITS	1.00mm Pitch FFC/FPC Connector
.X ±0.03	.X ±3°	SHEET SIZE	
.XX ±0.05	.XX ±2°	KLS P/N:	
Draw by: Date		2018-03-10	
Check by: Date		2018-03-10	
SCALE	SHEET	OF	L-KLS1-1240B-XX-R-B-AT

NingBo KLS ELECTRONIC CO.,LTD.

1 2 3 4 5 6 7 8

A

A

**Material**  
 Housing: PA9T, UL94V-0  
 Terminal: Phosphor Bronze

B

B

**Electrical**  
 Voltage rating: 50 V  
 Current Rating: 0.4 A  
 Withstanding Voltage: 200 V  
 Insulation resistance: 500M $\Omega$ .Min.  
 Contact resistance: 20 m $\Omega$ .Max.

**Mechanical**  
 Temp. Range: -25 °C ~ +85 °C

**Order Information**

L-KLS1- 1240B - XX-S-B-P T

RoHS \_\_\_\_\_  
 Series No. \_\_\_\_\_  
 No. of pins(04 ~ 30 pins) \_\_\_\_\_  
 S-Straight Pin \_\_\_\_\_  
 B-Black \_\_\_\_\_  
 P-Positive needle \_\_\_\_\_  
 Pack: T-Tube \_\_\_\_\_

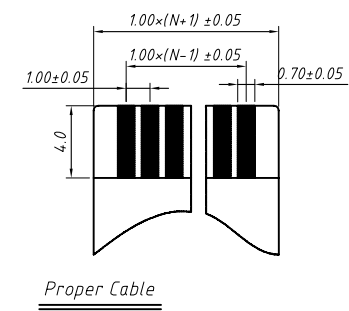
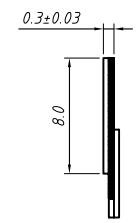
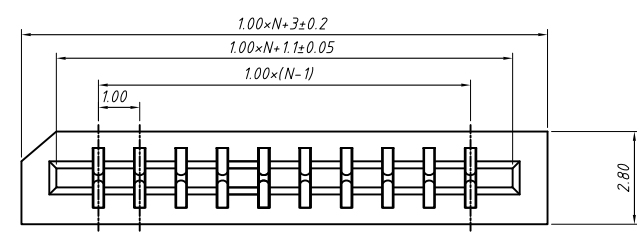

D

D

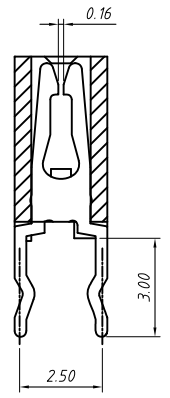
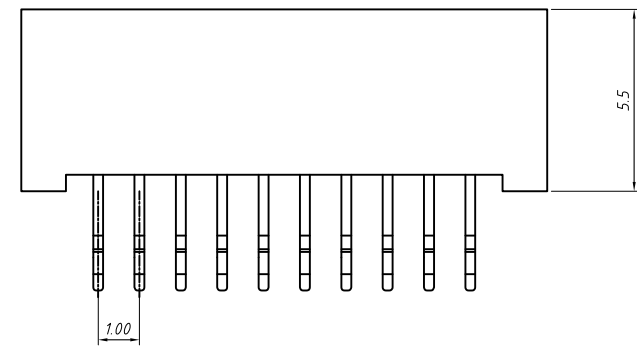

E

E

F

F

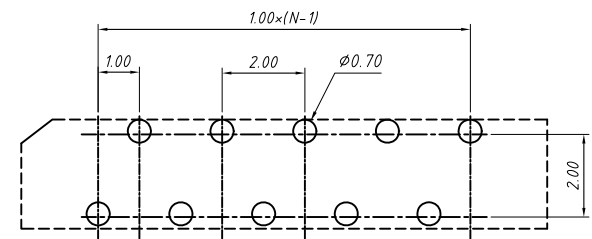

G

G

GENERAL TOLERANCE	ANGLE TOLERANCE	PROJECTION		Description:
X. ±0.15	X. ±5°	UNITS	mm	1.00mm Pitch FFC/FPC Connector
.X ±0.03	.X ±3°	SHEET SIZE	A4	
.XX ±0.05	.XX ±2°		KLS P/N:	

Draw by: Date 2018-03-10  
 Check by: Date 2018-03-10  
 SCALE SHEET OF

NingBo KLS ELECTRONIC CO.,LTD.

1 2 3 4 5 6 7 8

H

H

1 2 3 4 5 6 7 8

A

A

**Material**  
 Housing: PA9T, UL94V-0  
 Terminal: Phosphor Bronze

B

B

**Electrical**  
 Voltage rating: 50 V  
 Current Rating: 0.4 A  
 Withstanding Voltage: 200 V  
 Insulation resistance: 500M $\Omega$ .Min.  
 Contact resistance: 20 m $\Omega$ .Max.

**Mechanical**  
 Temp. Range: -25 °C ~ +85 °C

**Order Information**

L-KLS1- 1240B - XX-S-B-A T

RoHS \_\_\_\_\_  
 Series No. \_\_\_\_\_  
 No. of pins(04 ~ 30 pins) \_\_\_\_\_  
 S-Straight Pin \_\_\_\_\_  
 B-Black \_\_\_\_\_  
 A-Anti needle \_\_\_\_\_  
 Pack: T-Tube \_\_\_\_\_

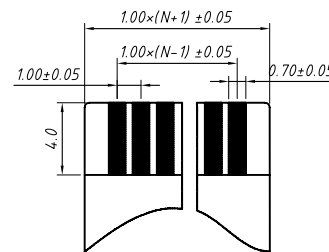
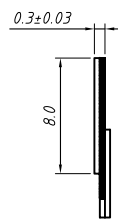
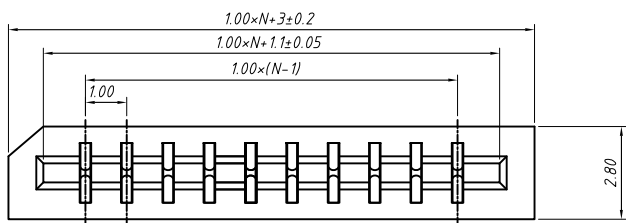

Proper Cable

D

D

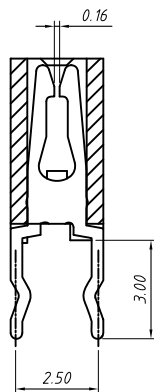
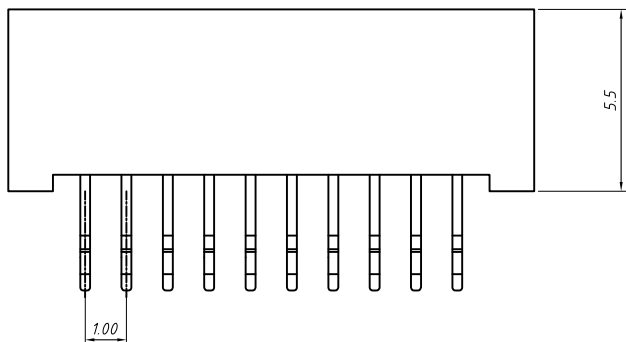

E

E

F

F

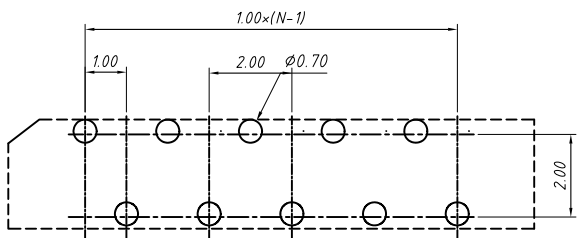

PCB Layout

H

H

GENERAL TOLERANCE	ANGLE TOLERANCE	PROJECTION		Description:
X. ±0.15	X. ±5°	UNITS	mm	1.00mm Pitch FFC/FPC Connector
.X ±0.03	.X ±3°	SHEET SIZE	A4	
.XX ±0.05	.XX ±2°		KLS P/N:	

Draw by: Date	2018-03-10
Check by: Date	2018-03-10
SCALE	SHEET OF

NingBo KLS ELECTRONIC CO.,LTD.

1 2 3 4 5 6 7 8

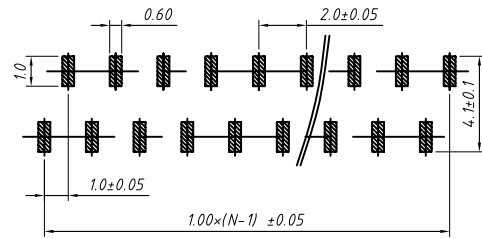

PCB Layout

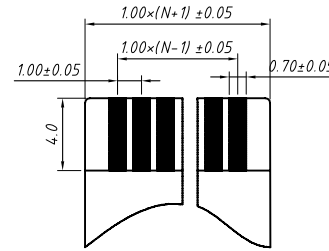
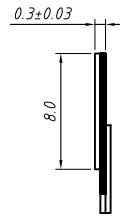

Proper Cable

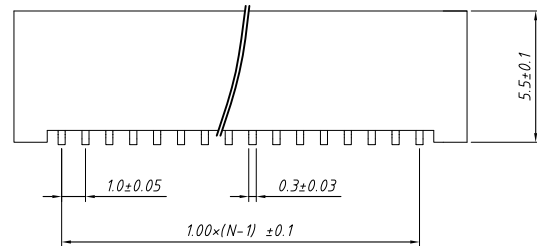
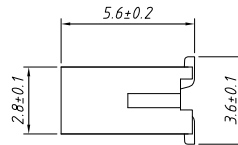
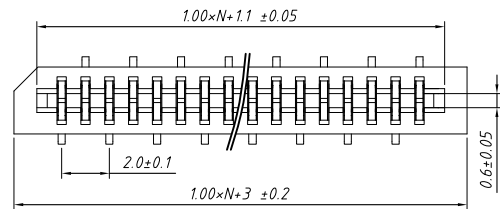

**Material**  
Housing: PA9T, UL94V-0  
Terminal: Phosphor Bronze

**Electrical**  
Voltage rating: 50 V  
Current Rating: 0.4 A  
Withstanding Voltage: 200 V  
Insulation resistance: 500M $\Omega$ .Min.  
Contact resistance: 20 m $\Omega$ .Max.

**Mechanical**  
Temp. Range: -25 °C ~ +85 °C

**Order Information**

L-KLS1- 1240B - XX-T-B-P T

RoHS \_\_\_\_\_  
Series No. \_\_\_\_\_  
No. of pins (04 ~ 30 pins) \_\_\_\_\_  
T-SMT Pin \_\_\_\_\_  
B-Black \_\_\_\_\_  
P-Positive needle \_\_\_\_\_  
Pack: T-Tube R-Reel \_\_\_\_\_

GENERAL TOLERANCE	ANGLE TOLERANCE	PROJECTION		Description:
X. $\pm 0.15$	X. $\pm 5^\circ$	UNITS	mm	1.00mm Pitch FFC/FPC Connector
.X $\pm 0.03$	.X $\pm 3^\circ$	SHEET SIZE	A4	
.XX $\pm 0.05$	.XX $\pm 2^\circ$		KLS P/N:	

Draw by: Date 2018-03-10  
Check by: Date 2018-03-10  
SCALE SHEET OF



NingBo KLS ELECTRONIC CO.,LTD.

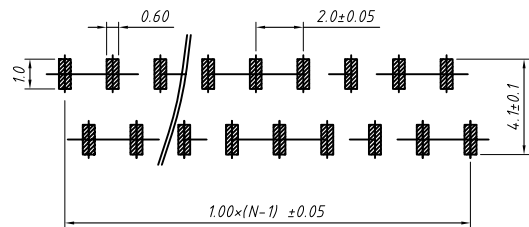

PCB Layout

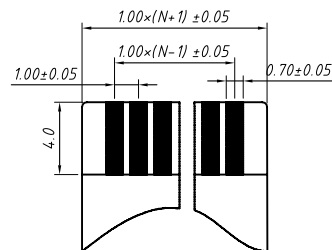
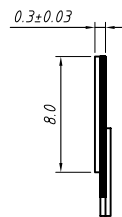

Proper Cable

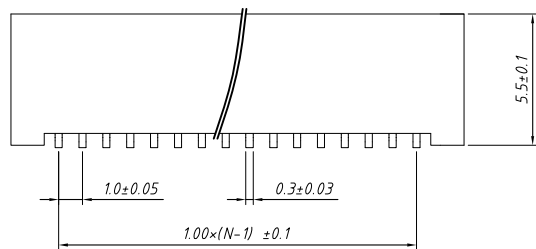
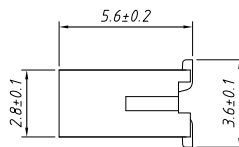
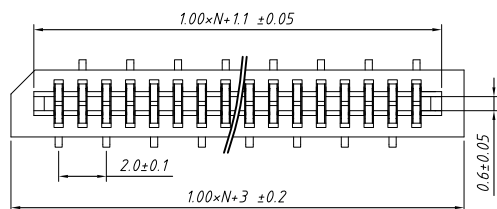

Material  
Housing:PA9T, UL94V-0  
Terminal:Phosphor Bronze

Electrical  
Voltage rating: 50 V  
Current Rating: 0.4 A  
Withstanding Voltage: 200 V  
Insulation resistance: 500M $\Omega$ .Min.  
Contact resistance: 20 m $\Omega$ .Max.

Mechanical  
Temp. Range: -25 °C ~ + 85 °C

Order Information

L-KLS1- 1240B - XX-T-B-A T

RoHS \_\_\_\_\_  
Series No. \_\_\_\_\_  
No. of pins(04 ~ 30 pins) \_\_\_\_\_  
T-SMT Pin \_\_\_\_\_  
B-Black \_\_\_\_\_  
A-Anti needle \_\_\_\_\_  
Pack: T-Tube R-Reel \_\_\_\_\_

GENERAL TOLERANCE	ANGLE TOLERANCE	PROJECTION		Description:
X. $\pm 0.15$	X. $\pm 5^\circ$	UNITS	mm	1.00mm Pitch FFC/FPC Connector
.X $\pm 0.03$	.X $\pm 3^\circ$	SHEET SIZE	A4	
.XX $\pm 0.05$	.XX $\pm 2^\circ$		KLS P/N:	

Draw by: Date 2018-03-10  
Check by: Date 2018-03-10  
SCALE SHEET OF



NingBo KLS ELECTRONIC CO.,LTD.