

1 RoHS Compliance

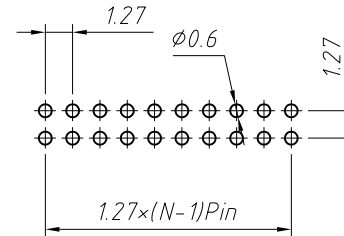
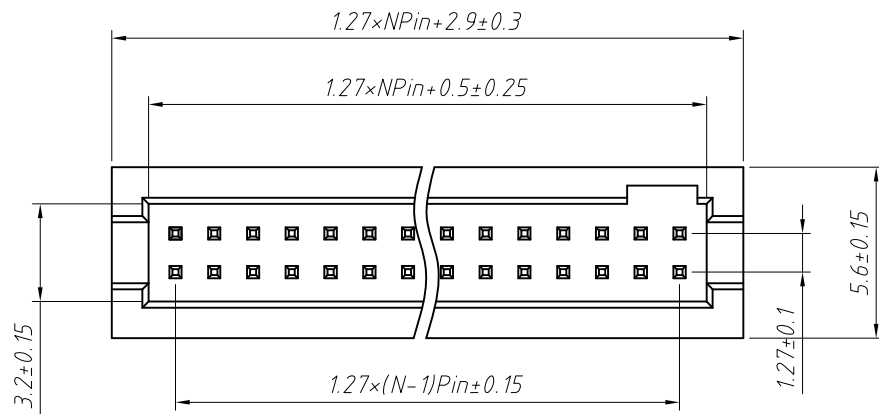

Recommended P.C.B Layout (Top Side)  
(PCB BOARD TOLERANCE±0.05)

Material:  
Housing:PA6T or LCP,UL94V-0  
Contact:Brass  
Plating:Gold plated

Electrical Characteristics:  
Rated Current: 1.0AMP  
Contact Resistance: 20mΩ Max  
Withstand Voltage: 500V AC/DC  
Insulator Resistance: 1000MΩ Min

Mechanical  
Operating Temperature: -40°C~+105°C  
Max.Processing Temp:230°C for 30-60 seconds (260°C for 10 seconds)

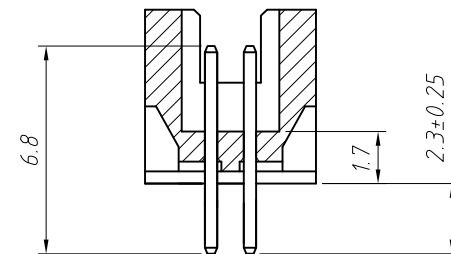
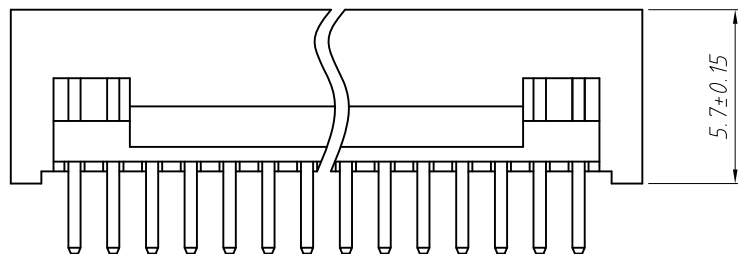

Order Information:

L-KLS1-202CB-XX-S-B-□

L: RoHS  
Box Header Series  
202CB:1.27mm Pitch  
XX-No.of 10~100 pins  
Type:S-Straight pin  
R-Right Angle Pin T-SMT  
Color:B-Black G-Gray  
Material:NONE=PA6T  
C=LCP D=PA9T



ANGLE TOLERANCE	PROJECTION	Description:
±3°		1.27x1.27mm Pitch Box Header Connector
GENERAL TOLERANCE	UNITS	mm
x.x ±0.30	SHEET SIZE	A4
x.xx ±0.20	Draw:	Daniel 2018-07-10
x.xxx ±0.10	Check:	Daniel 2018-07-10



NingBo KLS ELECTRONIC CO.,LTD.

1  
RoHS Compliance

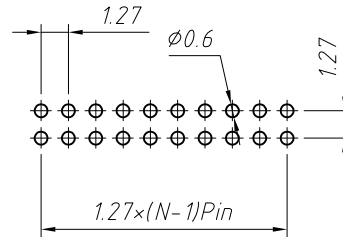
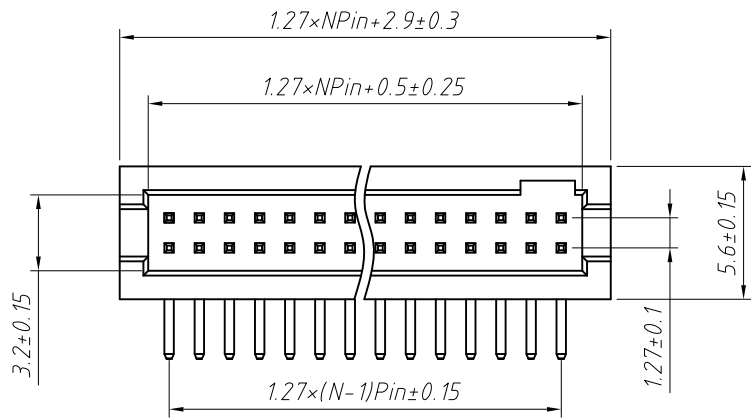

Recommended P.C.B Layout (Top Side)  
(PCB BOARD TOLERANCE±0.05)

Material:  
Housing:PA6T or LCP,UL94V-0  
Contact:Brass  
Plating:Gold plated

Electrical Characteristics:  
Rated Current: 1.0AMP  
Contact Resistance: 20mΩ Max  
Withstand Voltage: 500V AC/DC  
Insulator Resistance: 1000MΩ Min

Mechanical  
Operating Temperature: -40°C ~ +105°C  
Max.Processing Temp:230°C for 30-60 seconds (260°C for 10 seconds)

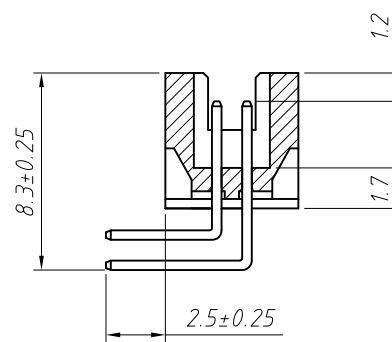
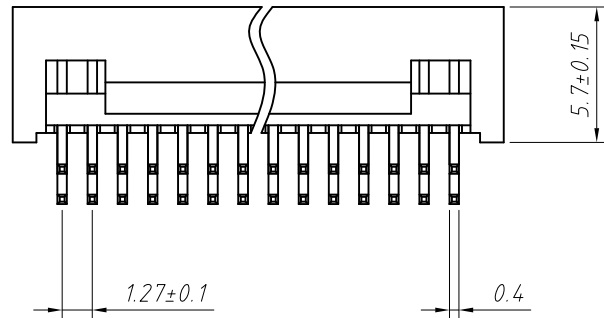

Order Information:

L-KLS1-202CB-XX-R-B-□

L: RoHS  
Box Header Series  
202CB:1.27mm Pitch  
XX-No.of 10 ~ 100 pins  
Type:S-Straight pin  
R-Right Angle Pin T-SMT  
Color:B-Black G-Gray  
Material:NONE=PA6T  
C=LCP D=PA9T

ANGLE TOLERANCE	PROJECTION	Description:	
±3°		1.27x1.27mm Pitch Box Header Connector	
GENERAL TOLERANCE	UNITS	mm	KLS P/N:
x.x ±0.30	SHEET SIZE	A4	L-KLS1-202CB-XX-R-B-□
x.xx ±0.20	Draw:	Daniel	2018-07-10
x.xxx ±0.10	Check:	Daniel	2018-07-10



NingBo KLS ELECTRONIC CO.,L TD.

1 RoHS Compliance

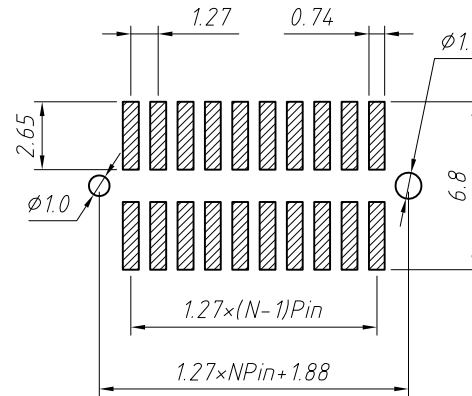
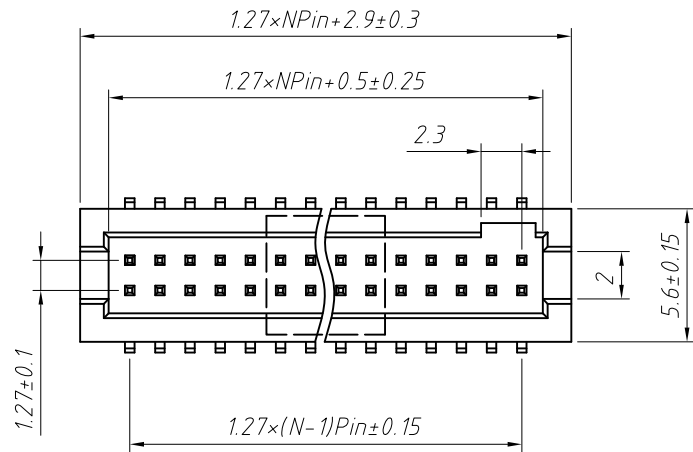

Recommended P.C.B Layout (Top Side)  
(PCB BOARD TOLERANCE ±0.05)

**Material:**  
Housing: PA6T or LCP, UL94V-0  
Contact: Brass  
Plating: Gold plated

**Electrical Characteristics:**  
Rated Current: 1.0AMP  
Contact Resistance: 20mΩ Max  
Withstand Voltage: 500V AC/DC  
Insulator Resistance: 1000MΩ Min

**Mechanical**  
Operating Temperature: -40°C ~ +105°C  
Max. Processing Temp: 230°C for 30-60 seconds (260°C for 10 seconds)

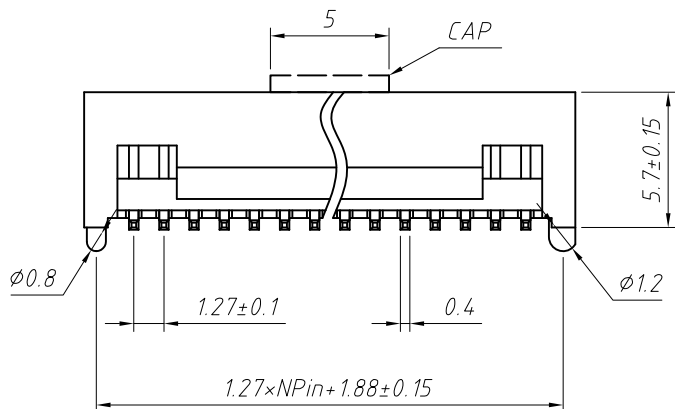

T3=With Post

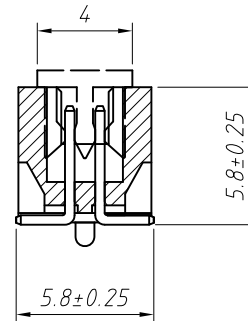

T=Without Post

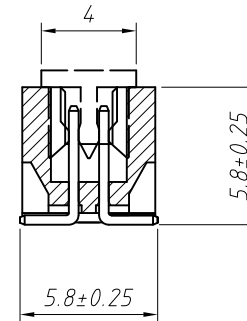

**Order Information:**

L-KLS1-202CB-XX-T-B-□-T

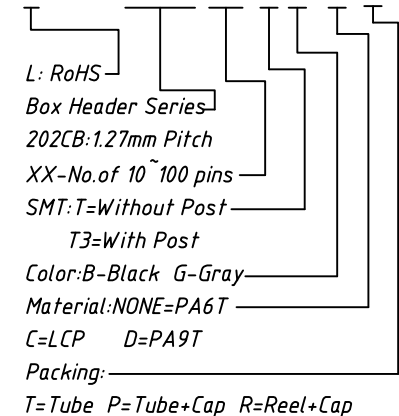

L: RoHS  
Box Header Series  
202CB: 1.27mm Pitch  
XX: No. of 10 ~ 100 pins  
SMT: T=Without Post  
T3=With Post  
Color: B=Black G=Gray  
Material: NONE=PA6T  
C=LCP D=PA9T  
Packing:  
T=Tube P=Tube+Cap R=Reel+Cap

ANGLE TOLERANCE	PROJECTION	Description:	
±3°		1.27x1.27mm Pitch Box Header Connector	
GENERAL TOLERANCE	UNITS	mm	KLS P/N:
x.x ±0.30	SHEET SIZE	A4	L-KLS1-202CB-XX-T-B-□-T
x.xx ±0.20	Draw:	Daniel	2018-07-10
x.xxx ±0.10	Check:	Daniel	2018-07-10



NingBo KLS ELECTRONIC CO.,LTD.