

1
RoHS Compliance

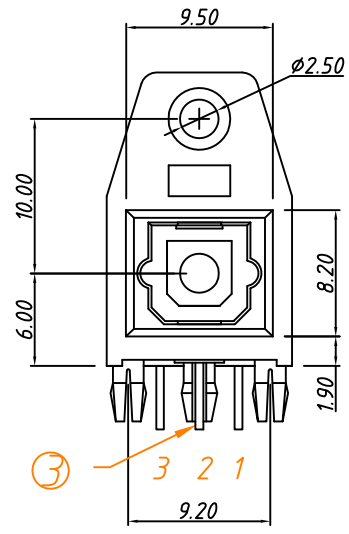

Pin Function
 1- GND
 2- Vcc
 3- Vin

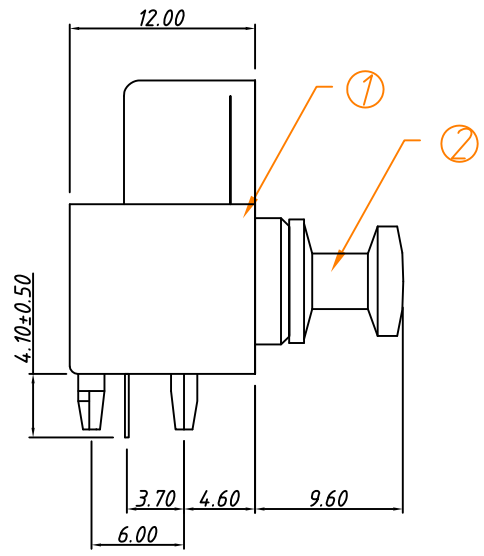
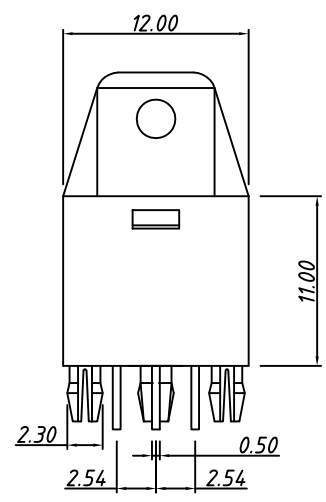
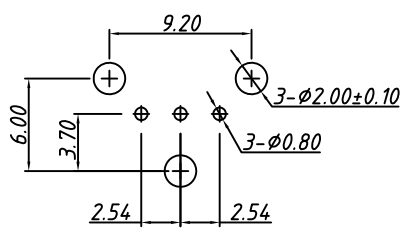

P.C.B LAYOUT
 TOLERANCE:±0.30

Order information:
 L-KLS1-SJ T -003-XXX
 L: RoHS
 T: Transmitter
 XXX: Frequency
 96K- 96KHz
 192K- 192KHz

3	IR		1	Transmitter
2	PLUG	PBT	1	
1	Body	PBT	1	
ITEM	PART NAME	Material	Q'TY	REMARK

PROJECTION		Description:
UNITS	mm	Transmitters FIBER OPTIC Jacks
SCALE	1:1	
Draw:	Daniel	KLS P/N: L-KLS1-SJT-003-XXX
Check :	Daniel	NingBo KLS ELECTRONIC CO.,L TD.
Date	2020-03-02	
TOLERANCE	±0.20	