

1
RoHS Compliance

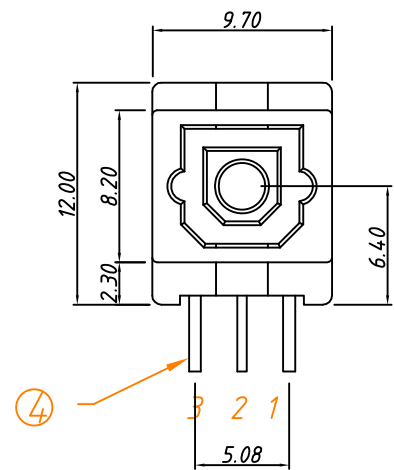

Pin Function
 1- Vout
 2- GND
 3- Vcc

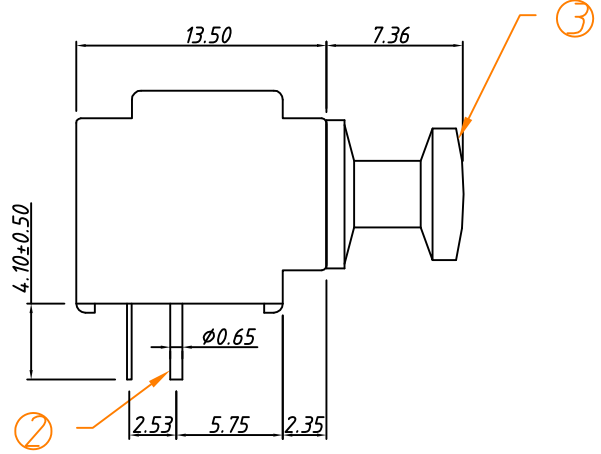
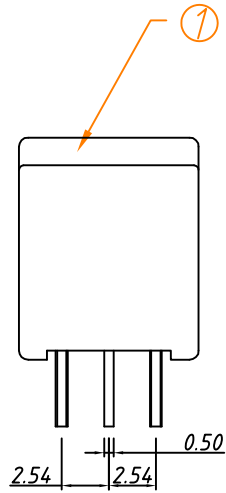
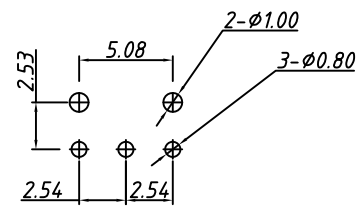

P.C.B LAYOUT
 TOLERANCE:±0.30

Order information:
 L-KLS1-SJ R -004-XXX
 L: RoHS
 R:Receiver
 XXX: Frequency
 96K- 96KHz
 192K- 192KHz

4	IR		1	Receiving
3	PLUG	PBT	1	
2	Pin	CP, Tin plated	2	
1	Body	PBT	1	
ITEM	PART NAME	Material	Q'TY	REMARK

PROJECTION		Description:
UNITS	mm	Receiver FIBER OPTIC Jacks
SCALE	1:1	
Draw:	Daniel	KLS P/N: L-KLS1-SJR-004-XXX
Check :	Daniel	NingBo KLS ELECTRONIC CO.,L TD.
Date	2020-03-02	
TOLERANCE	±0.20	