

1 RoHS Compliant

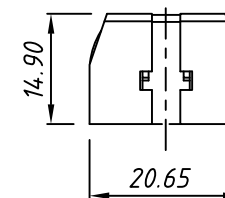
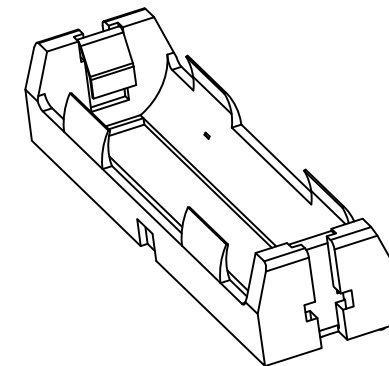
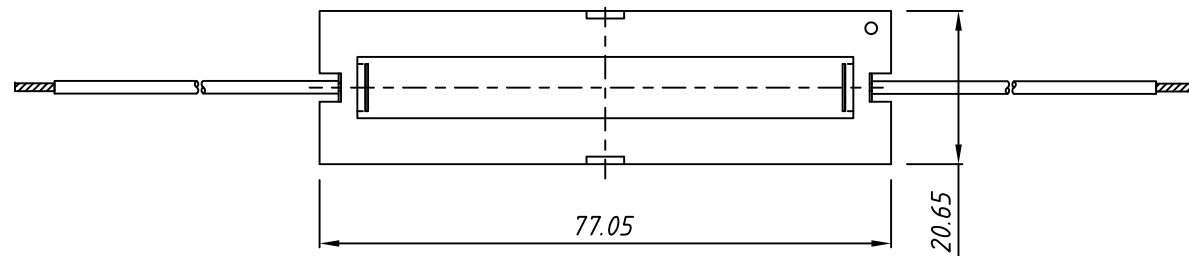
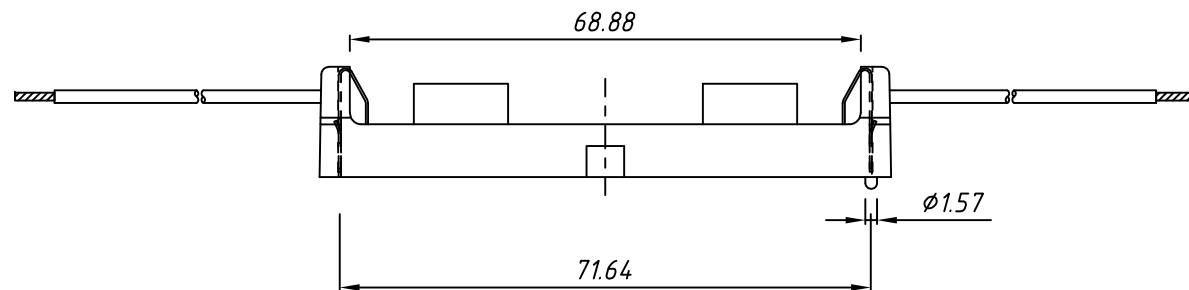
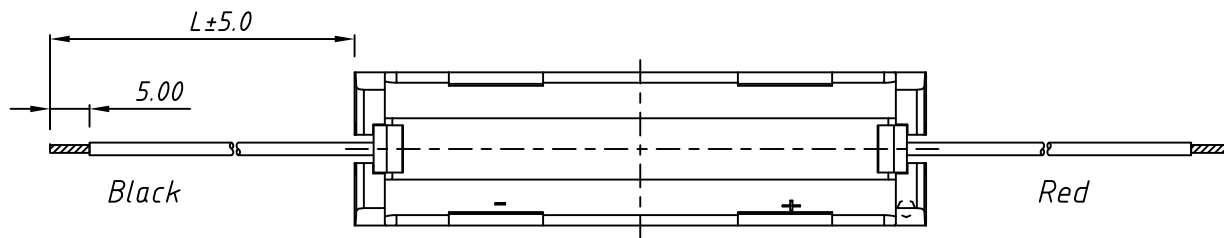

MATERIAL

Insulator: Nylon 66, Black, UL 94V-0

Contact: 0.35 Phosphor Bronze,
Nickel plated

ORDER INFORMATION:

L- KLS5 - 18650 - 014 - B LXXX

RoHS
1Li-ion 18650 Battery Holder
B : with Wire (22AWG)
Cable long:

GENERAL TOLERANCE	±0.50	PROJECTION	Description:	1Li-ion 18650 Battery Holder, with Wire
		UNITS		
Angle TOLERANCE	±3°	SHEET SIZE	A4	
		KLS P/N:		L-KLS5-18650-014-BLXXX
Draw:	Daniel	 NingBo KLS ELECTRONIC CO.,L TD.		
Check:	Daniel			
Data:	2019-03-08			