

RoHS Compliant

MATERIAL
 Insulator: ABS, Black, UL 94HB
 Contact: 304 Stainless Steel Spring
 Temper, Nickel plated

Series connection

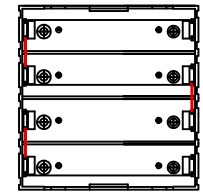

Parallel connection

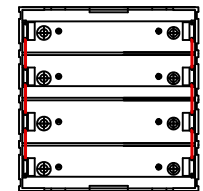

ORDER INFORMATION:

L - KLS5 - 18650-004 - B X LXXX

- RoHS
- 4 Li-ion 18650 Battery Holder
- B : with WIRE(22AWG)
- Circuit :
 - S-Series connection
 - P-Parallel connection
 - XXX: Cable Long

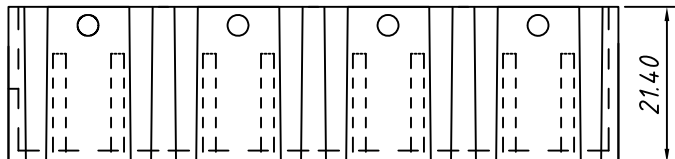

GENERAL TOLERANCE	±0.50	PROJECTION	Description:	4 Li-ion 18650 Battery Holder, with WIRE
		UNITS		
Angle TOLERANCE	±3°	SHEET SIZE	KLS P/N: L-KLS5-18650-004-BXLXXX	
Draw:	Daniel	 NingBo KLS ELECTRONIC CO.,L TD.		
Check:	Daniel			
Data:	2019-03-08			

RoHS Compliant

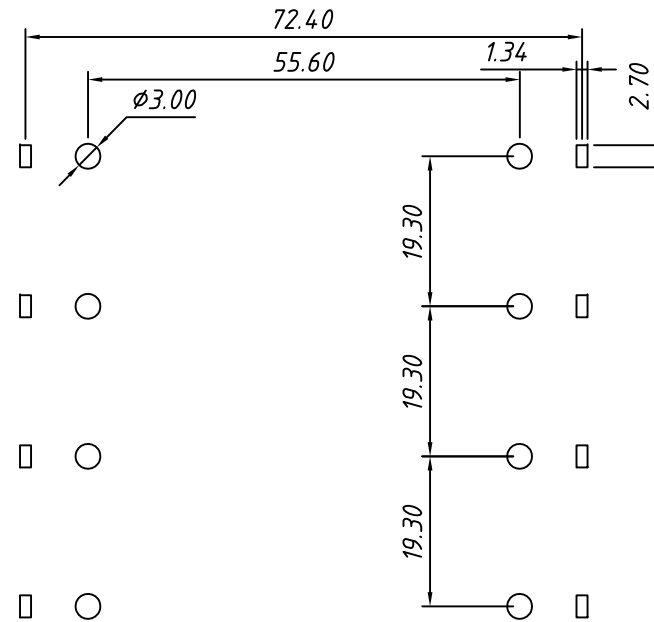
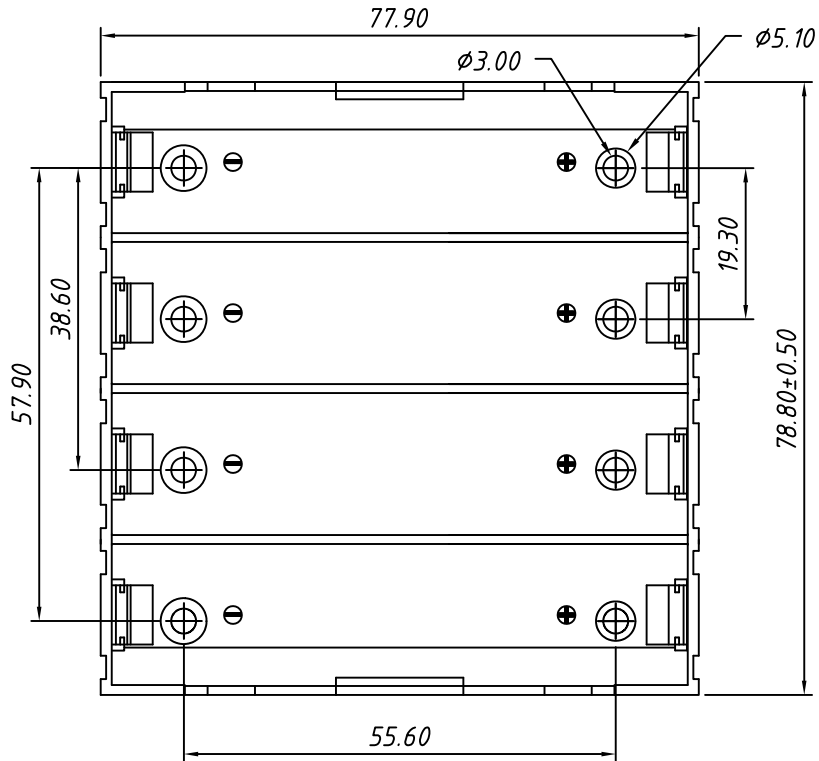

Series connection

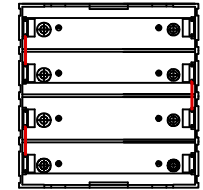

Parallel connection

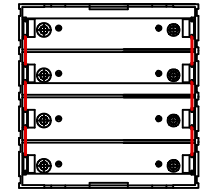

MATERIAL

Insulator: ABS,Black,UL 94HB

Contact: 304 Stainless Steel Spring
Temper,Nickel plated

RECOMMENDED PCB LAYOUT

TOLERANCE:±0.05

ORDER INFORMATION:

L - KLS5 - 18650 - 004 - D X

RoHS

4 Li-ion 18650 Battery Holder
D : with PC Pin

Circuit :

S-Series connection
P-Parallel connection

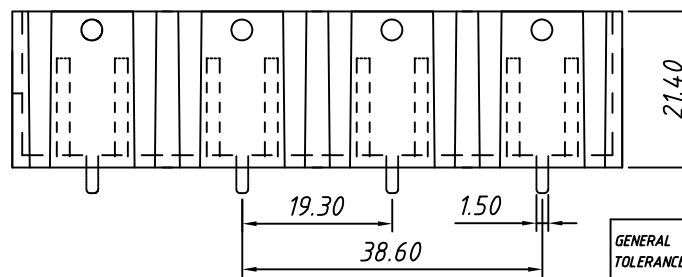
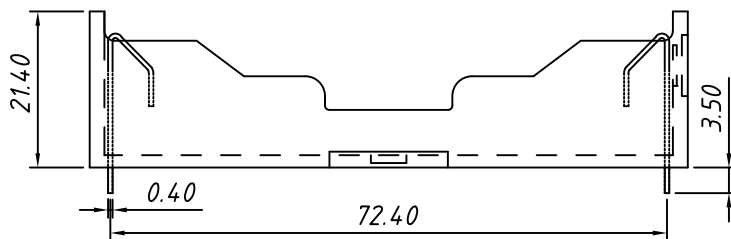

GENERAL TOLERANCE	±0.50	PROJECTION	Description:	4 Li-ion 18650 Battery Holder,with PC Pin
		UNITS		
Angle TOLERANCE	±3°	SHEET SIZE	A4	
		KLS P/N:		
Draw:	Daniel	 NingBo KLS ELECTRONIC CO.,L TD.		
Check:	Daniel			
Data:	2019-03-08			