

If the splint is 1 or 0.70MM, the terminal is bent on the automaton.

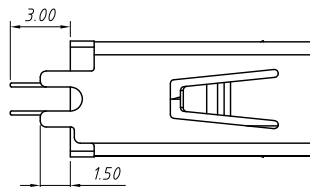
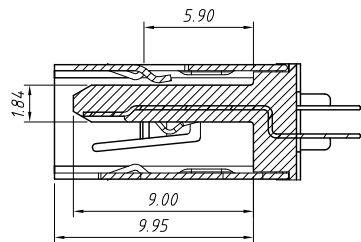
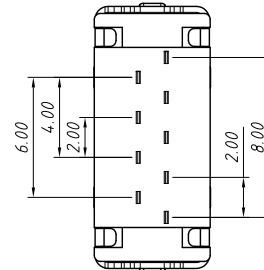
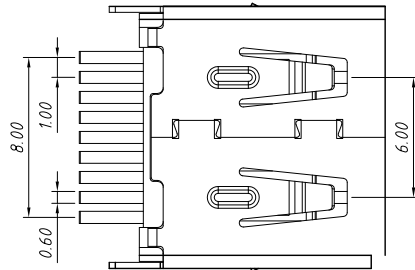
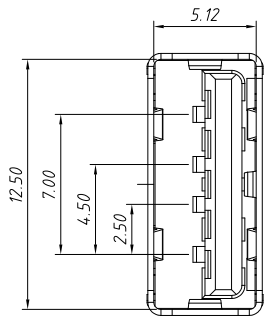
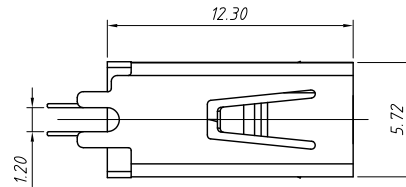

Material

Housing: PBT UL 94V-0, Blue

Terminal :C5191R-H T=0.20mm,

Nu" Gold Plated On Contact Area,
100-120U" Matte-Tin Plated On Solder Area
50-80U" Nickel Underplated Overall.

Shell : SPCC, T=0.30mm,Plating Nickel 80 ~ 120u".

Electrical

Contact Resistance: 30milli-OHMS MAX.

Dielectric Withstanding Voltage: 500V AC FOR 1MIN.

Insulation Resistance: 1000Mega-OHMS MIN.

Mechanical

Operating Temperature:-55°C TO +85°C.

Insertion Force: 35N(3.57KGF) MAX.

Extraction Force: 10 ~ 35N(1.02 ~ 3.57KGF)MIN.

Order Information

L-KLS1- 3015 - L

Color: L:Blue

USB AF 3.0

RoHS

GENERAL TOLERANCE		ANGLE TOLERANCE		PROJECTION		Description:	
.X	±0.60	.X	±5°	UNITS	mm	USB 3.0 Type A Female CONN. Board EDGE KLS1-3015	
.X	±0.38	.X	±3°	SHEET SIZE	A4		
.XX	±0.25	.XX	±2°	KLS P/N:			

Draw by: Date 2018-03-01

Check by: Date 2018-03-01

SCALE SHEET OF



NingBo KLS ELECTRONIC CO.,LTD.

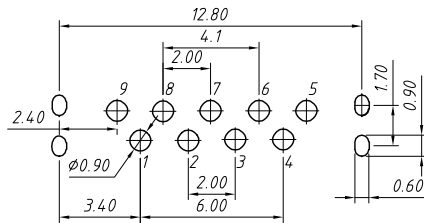
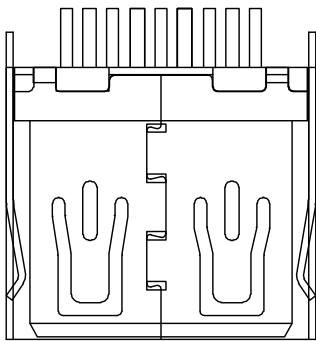
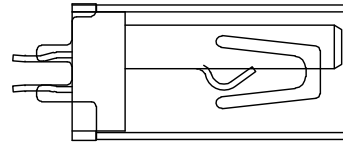
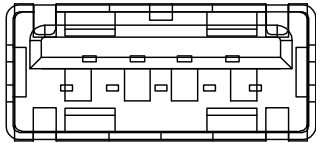
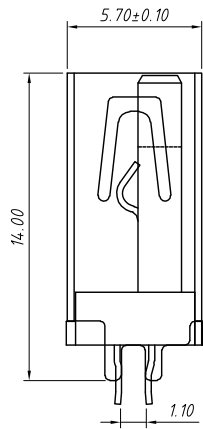
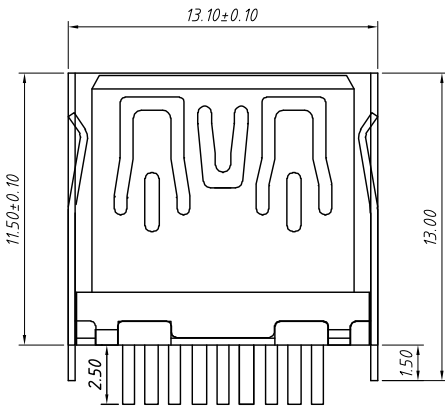

PIN	SIGNAL
1	USB Voltage
2	D-(Negative pole)
3	D+(positive electrode)
4	Ground
5	SSRX-
6	SSRX+
7	GND(Ground)
8	SSRX-
9	SSRX+
SHELL	SHEID

Material
 Housing: Hing Temperature Thermaplastics
 Terminal :Copper Alloy C2680,Plated Gold in Mating Area,Tin On Solder Talls
 Shell : Copper Alloy C2680/SPCC,Nickel Plating 80U"

Electrical
 Current Rating:15A/contact terminal
 Voltage Rating:30V DC

Contact Resistance: 30milli-OHMS MAX.
 Dielectric Withstanding Voltage: 500V AC FOR 1MIN.
 Insulation Resistance: 1000Mega-OHMS MIN.

Mechanical
 Operating Temperature:-55°C TO +85°C.
 Mating Force: 3.57kgf MAX
 Unmating Force: 1.05kgf MIN.

Order Information

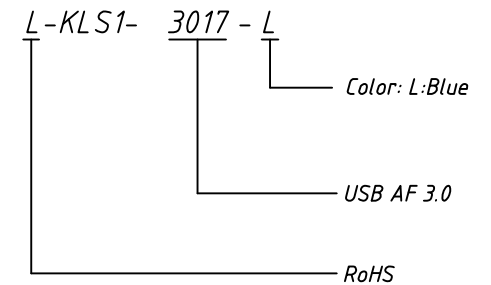

GENERAL TOLERANCE	ANGLE TOLERANCE	PROJECTION	Description:
X. ±0.60	X. ±5°	UNITS	USB 3.0 Type A Female CONN. Board EDGE 0.8mm KLS1-3017
.X ±0.38	.X ±3°	SHEET SIZE	
.XX ±0.25	.XX ±2°	KLS P/N:	

Draw by: Date 2018-03-01

Check by: Date 2018-03-01

SCALE SHEET OF



NingBo KLS ELECTRONIC CO.,LTD.