

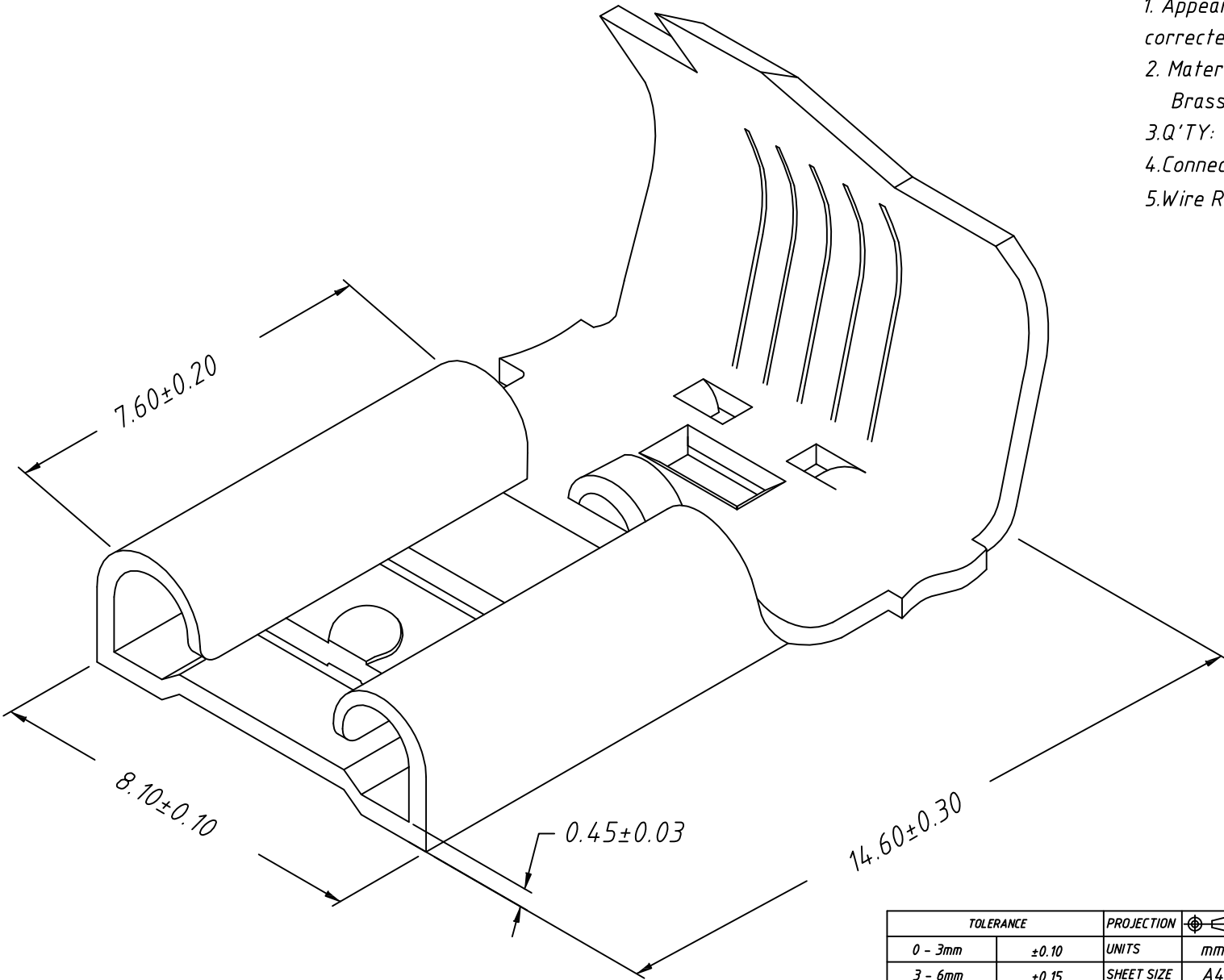

1
RoHS Compliant



Note:
 1. Appearance: Terminal cannot be corrected, scratched or oxidized
 2. Material:
 Brass C2680, T=0.45mm, Tin plating
 3. Q'TY: 1000PCS/REEL
 4. Connectoin Table: W6.35×T0.80mm
 5. Wire Range: 16~18AWG

TOLERANCE		PROJECTION	Description:		
0 - 3mm	±0.10	UNITS	mm		
3 - 6mm	±0.15	SHEET SIZE	A4		
6 - 10mm	±0.20	KLS P/N: KLS8-DFR06-2500800			
10 - 30mm	±0.25	 NingBo KLS ELECTRONIC CO.,L TD.			
Draw:	Daniel			ANGLE	±3°
Check:	Daniel			Data:	2019-04-10