

1
RoHS Compliant

Note:
 1. Appearance: Terminal cannot be corrected, scratched or oxidized
 2. Material:
 Brass C2680, T=0.30mm, Tin plating
 3. Q'TY: 8000PCS/REEL
 4. Wire Range: 18~22AWG

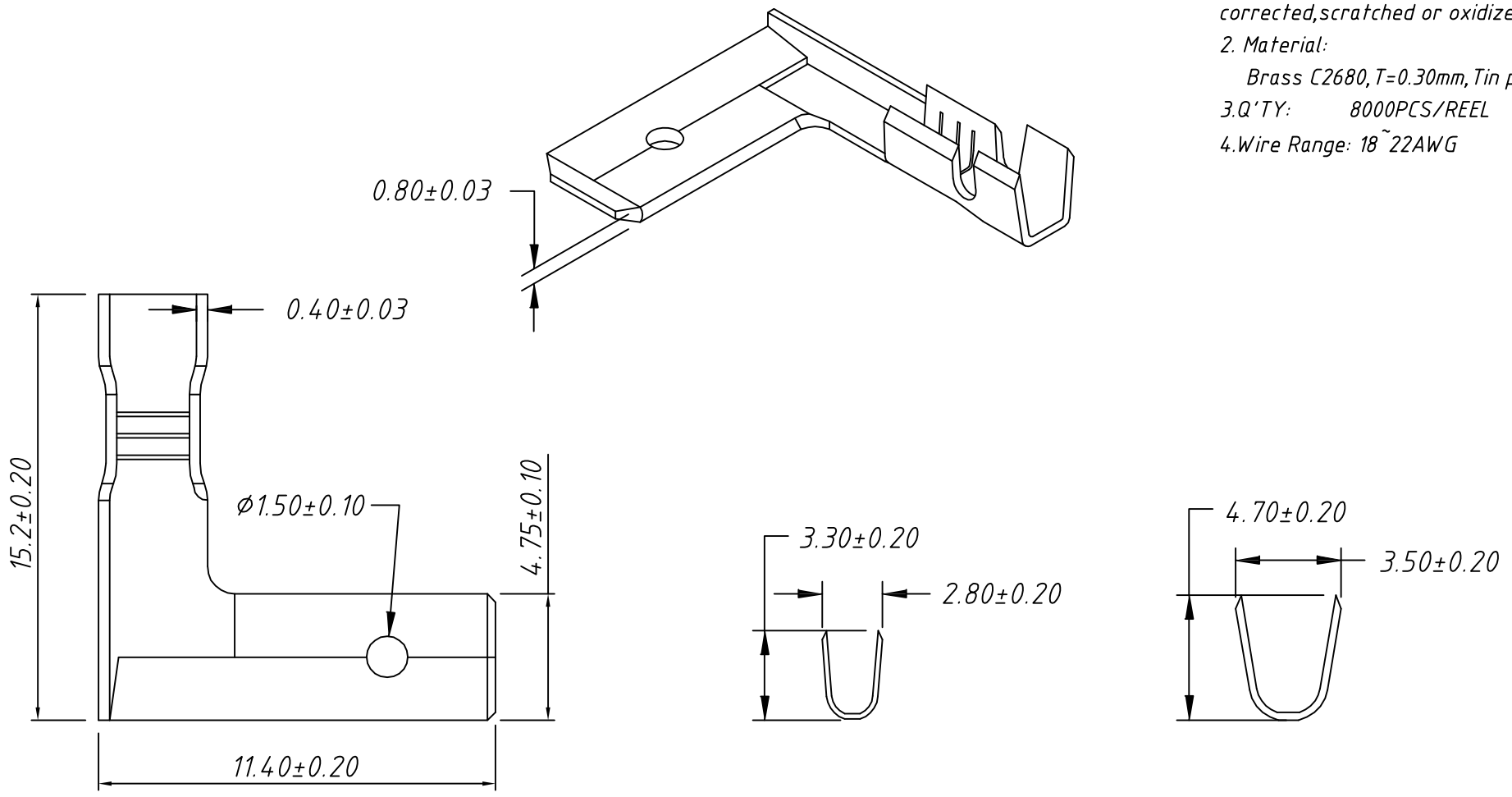

TOLERANCE		PROJECTION	Description:
0 - 3mm	±0.10	UNITS	187 Type Male TERM. for Cable
3 - 6mm	±0.15	SHEET SIZE	
6 - 10mm	±0.20	KLS P/N: KLS8-BMN05-1870800	
10 - 30mm	±0.25		

Draw: Daniel ANGLE ±3°
 Check: Daniel Data: 2019-04-10

KLS NingBo KLS ELECTRONIC CO.,L TD.