

PACKAGE DIMENSION mm

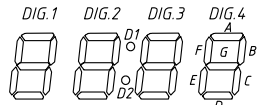

INTERNAL CIRCUIT DIAGRAM

Common Cathode  
L-KLS9-D-4741 Ax

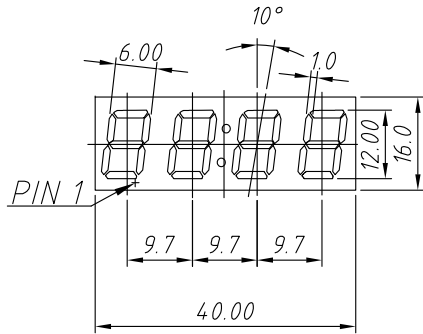
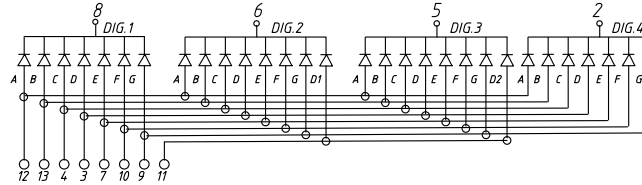

Common Anode  
L-KLS9-D-4741 Bx

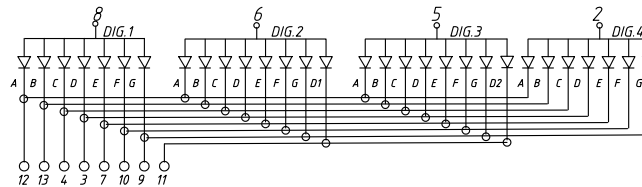

| Color Code | Emitting Color | Peak Wavelength<br>nm | Forward Voltage<br>V <sub>F</sub> /Seg. |      | Luminous Intensity I <sub>v</sub> /Seg. |      |
|------------|----------------|-----------------------|---|------|---|------|
|            |                |                       | Typ.                                    | Max. | Min.                                    | Typ. |
|            |                |                       | V                                       |      | mcd                                     |      |
| UHR        | Ultra Red      | 640                   | 2                                       | 2.5  | 40                                      | 60   |
| UE         | Orange         | 615                   | 2                                       | 2.5  | 40                                      | 60   |
| H          | Red            | 623                   | 2.25                                    | 2.5  | 0.4                                     | 0.8  |
| YO         | Amber          | 605                   | 2                                       | 2.5  | 40                                      | 60   |
| UY         | Yellow         | 590                   | 2                                       | 2.5  | 40                                      | 60   |
| UG         | Green          | 568                   | 2.1                                     | 2.5  | 25                                      | 40   |
| PG         | Pure Green     | 525                   | 3.3                                     | 3.8  | 150                                     | 200  |
| UB         | Blue           | 465                   | 3.3                                     | 3.8  | 40                                      | 100  |
| UW         | White          |                       | 3.3                                     | 3.8  | 200                                     | 500  |

Electro/Optical Characteristics I<sub>f</sub>=20mA Ta=25°C

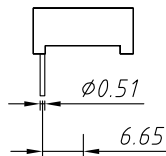
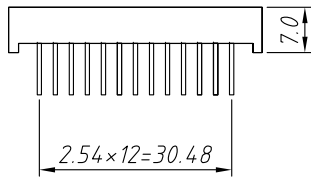

Order information

L-KLS9-D-47 4 1 A XX -X X

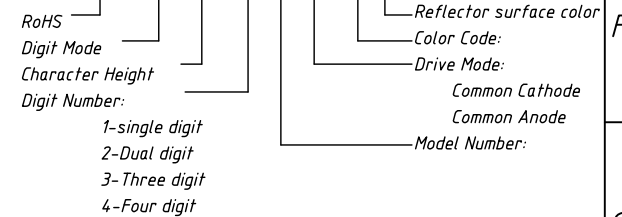

Maximum Ratings Ta=25°C (Derate above 25°C)

| Characteristic                 | Test Condition                       | Symbol          | Units | Ultra Red | Orange | Red  | Amber | Yellow | Green | Pure Green | Blue  | White |
|--------------------------------|--------------------------------------|-----------------|-------|-----------|--------|------|-------|--------|-------|------------|-------|-------|
|                                |                                      |                 |       | UHR       | UE     | H    | YO    | UY     | UG    | PG         | UB    | UW    |
| Pulse Forward Current Per Seg. | 1/10 duty cycle<br>0.1ms Pulse width | I <sub>FP</sub> | mA    | 100       | 100    | 50   | 100   | 100    | 100   | 100        | 100   | 100   |
| DC Forward Current Per Seg.    |                                      | I <sub>F</sub>  | mA    | 30        | 30     | 15   | 30    | 30     | 30    | 30         | 30    | 30    |
| Reverse Current Per Seg.       | V <sub>R</sub> =5V                   | I <sub>R</sub>  | A     | 10        | 10     | 10   | 10    | 10     | 10    | 10         | 10    | 10    |
| Power Dissipation              |                                      | P <sub>D</sub>  | mW    | 65×8      | 65×8   | 40×8 | 65×8  | 65×8   | 75×8  | 110×8      | 120×8 | 120×8 |

|            |                       |              |  |
|------------|-----------------------|--------------|--|
| Tolerance: | ±0.25mm unless stated | Description: | 0.47" Single Digit<br>7 Segment DISPLAYS |
| PROJECTION |                       | KLS P/N:     | L-KLS9-D-4741XXXXX                       |
| UNITS      | mm                    |              |  |
| SHEET SIZE | A4                    |              | NingBo KLS ELECTRONIC CO.,L TD.          |
| Draw data  | 2018-1-25             |              |  |
| Check data | 2018-1-25             |              |  |