

PACKAGE DIMENSION mm

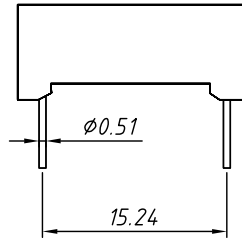

INTERNAL CIRCUIT DIAGRAM

Common Cathode  
L-KLS9-D-5611 Ax

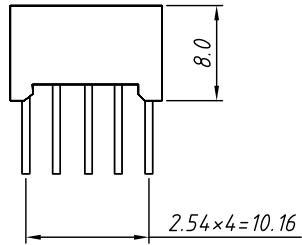
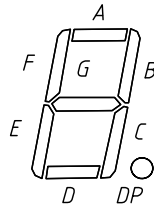
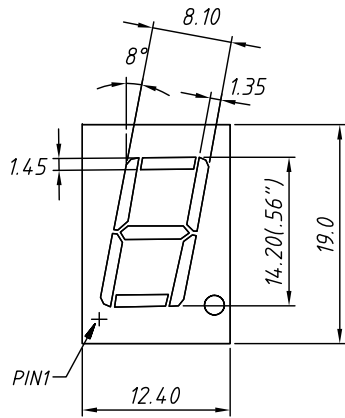
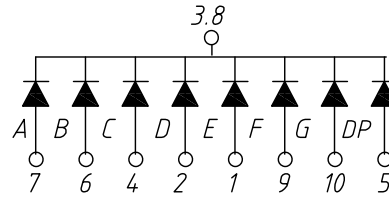

Common Anode  
L-KLS9-D-5611 Bx

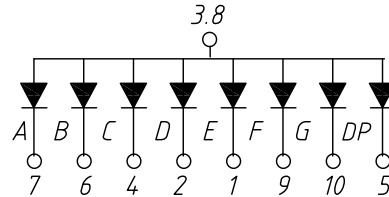

Color Code	Emitting Color	Peak Wavelength	Forward Voltage $V_f$ /Seg.		Luminous Intensity $I_v$ /Seg.	
			Typ.	Max.	Min.	Typ.
		nm	V		mcd	
UHR	Ultra Red	640	2	2.5	40	60
UE	Orange	615	2	2.5	40	60
H	Red	623	2.25	2.5	0.4	0.8
YO	Amber	605	2	2.5	40	60
UY	Yellow	590	2	2.5	40	60
UG	Green	568	2.1	2.5	25	40
PG	Pure Green	525	3.3	3.8	150	200
UB	Blue	465	3.3	3.8	40	100
UW	White		3.3	3.8	200	500

Electro/Optical Characteristics  $I_f=20mA$   $T_a=25^\circ C$

Order information

L-KLS9-D-56 1 1 A XX -X X

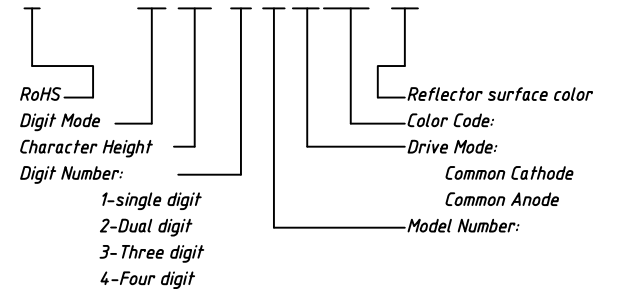

Maximum Ratings  $T_a=25^\circ C$  (Derate above  $25^\circ C$ )

Characteristic	Test Condition	Symbol	Units	Ultra Red	Orange	Red	Amber	Yellow	Green	Pure Green	Blue	White
				UHR	UE	H	YO	UY	UG	PG	UB	UW
Pulse Forward Current Per Seg.	1/10 duty cycle 0.1ms Pulse width	$I_{FP}$	mA	100	100	50	100	100	100	100	100	100
DC Forward Current Per Seg.		$I_F$	mA	30	30	15	30	30	30	30	30	30
Reverse Current Per Seg.	$V_R=5V$	$I_R$	A	10	10	10	10	10	10	10	10	10
Power Dissipation		$P_D$	mW	65x8	65x8	40x8	65x8	65x8	75x8	110x8	120x8	120x8

Tolerance:	$\pm 0.25mm$ unless stated	Description:	0.56" Single Digit 7 Segment DISPLAYS
PROJECTION		KLS P/N:	L-KLS9-D-5611XXXXX
UNITS	mm		
SHEET SIZE	A4		
Draw data	2018-1-25		NingBo KLS ELECTRONIC CO.,L TD.
Check data	2018-1-25		

PACKAGE DIMENSION mm

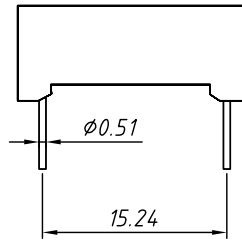
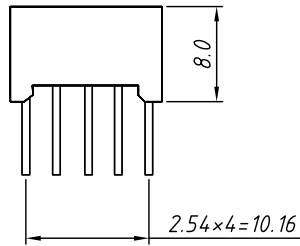
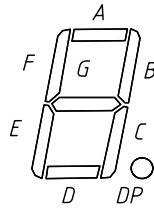
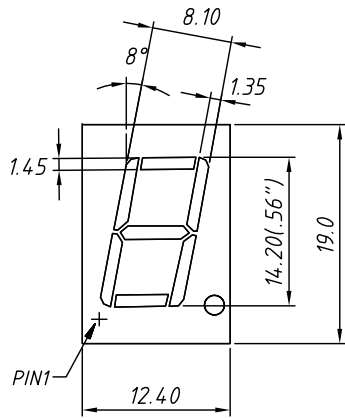

INTERNAL CIRCUIT DIAGRAM

Common Cathode  
L-KLS9-D-5611 Cx

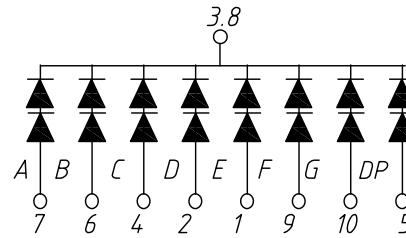

Common Anode  
L-KLS9-D-5611 Dx

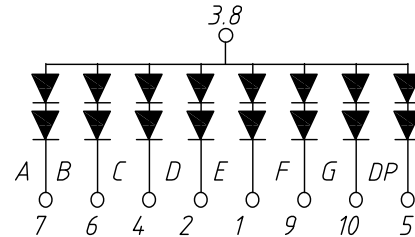

Color Code	Emitting Color	Peak Wavelength nm	Forward Voltage V <sub>F</sub> /Seg.		Luminous Intensity I <sub>v</sub> /Seg.	
			Typ.	Max.	Min.	Typ.
			V		mcd	
UHR	Ultra Red	640	2	2.5	40	60
UE	Orange	615	2	2.5	40	60
H	Red	623	2.25	2.5	0.4	0.8
YO	Amber	605	2	2.5	40	60
UY	Yellow	590	2	2.5	40	60
UG	Green	568	2.1	2.5	25	40
PG	Pure Green	525	3.3	3.8	150	200
UB	Blue	465	3.3	3.8	40	100
UW	White		3.3	3.8	200	500

Electro/Optical Characteristics I<sub>f</sub>=20mA Ta=25°C

Order information

L-KLS9-D-56 1 1 C XX -X X

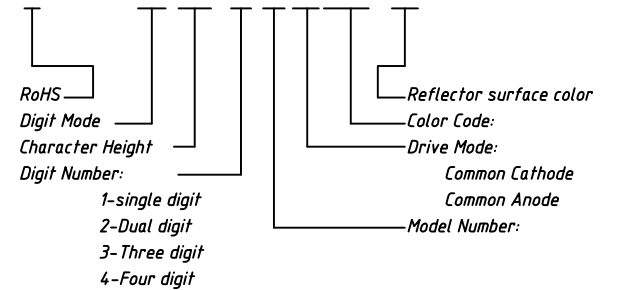

Maximum Ratings Ta=25°C (Derate above 25°C)

Characteristic	Test Condition	Symbol	Units	Ultra Red	Orange	Red	Amber	Yellow	Green	Pure Green	Blue	White
				UHR	UE	H	YO	UY	UG	PG	UB	UW
Pulse Forward Current Per Seg.	1/10 duty cycle 0.1ms Pulse width	I <sub>FP</sub>	mA	100	100	50	100	100	100	100	100	100
DC Forward Current Per Seg.		I <sub>F</sub>	mA	30	30	15	30	30	30	30	30	30
Reverse Current Per Seg.	V <sub>R</sub> =5V	I <sub>R</sub>	A	10	10	10	10	10	10	10	10	10
Power Dissipation		P <sub>D</sub>	mW	65×8	65×8	40×8	65×8	65×8	75×8	110×8	120×8	120×8

Tolerance:	±0.25mm unless stated	Description:	0.56" Single Digit 7 Segment DISPLAYS
PROJECTION		KLS P/N:	L-KLS9-D-5611XXXXX
UNITS	mm		
SHEET SIZE	A4		NingBo KLS ELECTRONIC CO.,L TD.
Draw data	2018-1-25		
Check data	2018-1-25		

PACKAGE DIMENSION mm

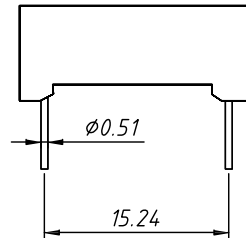
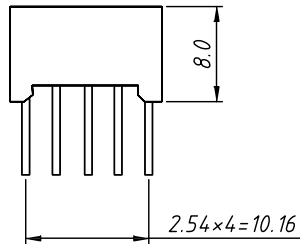
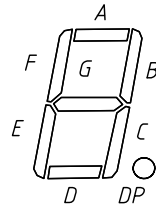
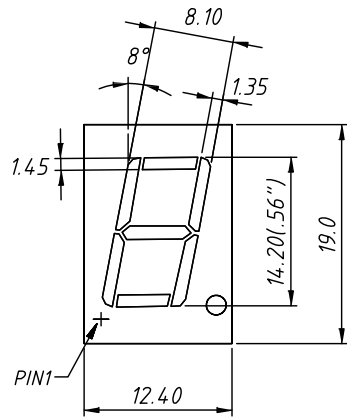

INTERNAL CIRCUIT DIAGRAM

Common Cathode  
L-KLS9-D-5611 Ex

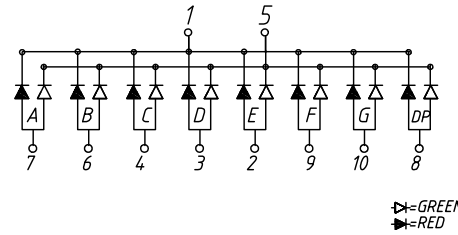

Common Anode  
L-KLS9-D-5611 Fx

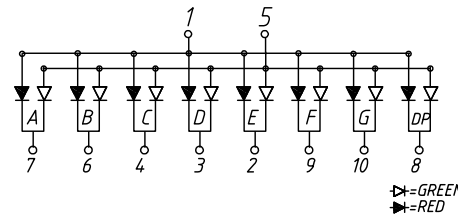

Color Code	Emitting Color	Peak Wavelength nm	Forward Voltage V <sub>F</sub> /Seg.		Luminous Intensity I <sub>v</sub> /Seg.	
			Typ.	Max.	Min.	Typ.
			V		mcd	
UHR	Ultra Red	640	2	2.5	40	60
UE	Orange	615	2	2.5	40	60
H	Red	623	2.25	2.5	0.4	0.8
YO	Amber	605	2	2.5	40	60
UY	Yellow	590	2	2.5	40	60
UG	Green	568	2.1	2.5	25	40
PG	Pure Green	525	3.3	3.8	150	200
UB	Blue	465	3.3	3.8	40	100
UW	White		3.3	3.8	200	500

Electro/Optical Characteristics I<sub>f</sub>=20mA Ta=25°C

Order information

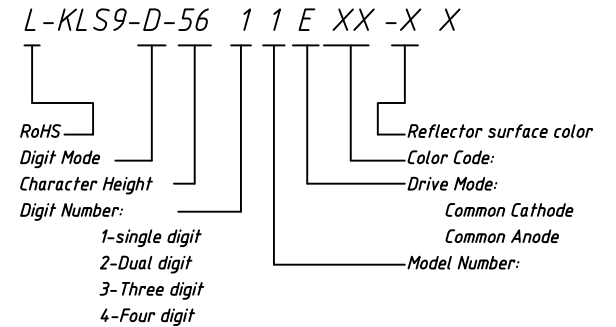

Maximum Ratings Ta=25°C (Derate above 25°C)

Characteristic	Test Condition	Symbol	Units	Ultra Red	Orange	Red	Amber	Yellow	Green	Pure Green	Blue	White
				UHR	UE	H	YO	UY	UG	PG	UB	UW
Pulse Forward Current Per Seg.	1/10 duty cycle 0.1ms Pulse width	I <sub>FP</sub>	mA	100	100	50	100	100	100	100	100	100
DC Forward Current Per Seg.		I <sub>F</sub>	mA	30	30	15	30	30	30	30	30	30
Reverse Current Per Seg.	V <sub>R</sub> =5V	I <sub>R</sub>	A	10	10	10	10	10	10	10	10	10
Power Dissipation		P <sub>D</sub>	mW	65×8	65×8	40×8	65×8	65×8	75×8	110×8	120×8	120×8

Tolerance:	±0.25mm unless stated	Description:	0.56" Single Digit 7 Segment DISPLAYS
PROJECTION			
UNITS	mm		LS9-D-5611XXXXX
SHEET SIZE	A4		
Draw data	2018-1		
Check data	2018-1		LS ELECTRONIC CO.,L TD.