

Material
 Housing: PA66, UL 94V-0
 Screws: M2.5, Steel, Zn Plated
 Clamp: Phosphor bronze, Ni Plated
 Wire guard: Stainless steel



Electrical
 Rated voltage: 300V
 Rated current: 8A
 Contact Resistance: 20 mΩ
 Insulation resistance: 500MΩ/DC500V
 Withstand voltage: AC2000V / 1 min
 Wire Range: 28 ~ 16AWG 1.0mm²

Mechanical
 Temp. Range: -40 °C ~ +105 °C
 Strip length: 7 ~ 8 mm
 Torque: 0.4Nm(3.6 bin)

Order Information

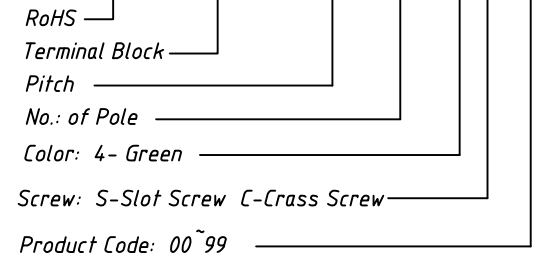
L-KLS2-EDGKDM-3.50-XXP-4S-00



GENERAL TOLERANCE		ANGLE TOLERANCE		Description:	
X. ±0.60		X. ±5°		Pluggable Terminal Block 3.50MM	
.X ±0.38		.X ±3°		KLS P/N:	KLS2-EDGKDM-3.50-XXP-4S-00
.XX ±0.25		.XX ±2°		 NingBo KLS ELECTRONIC CO.,L TD.	
Draw by	2015-09-01	PROJECTION			
Check by	2015-09-15	UNITS	mm		
SCALE		SHEET SIZE	A4		

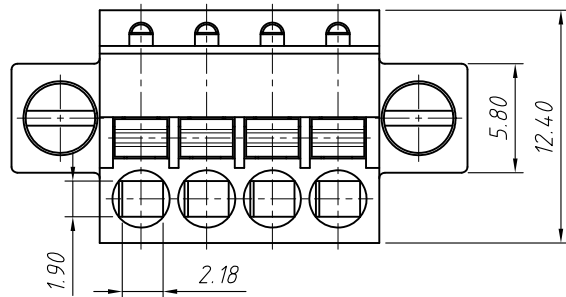
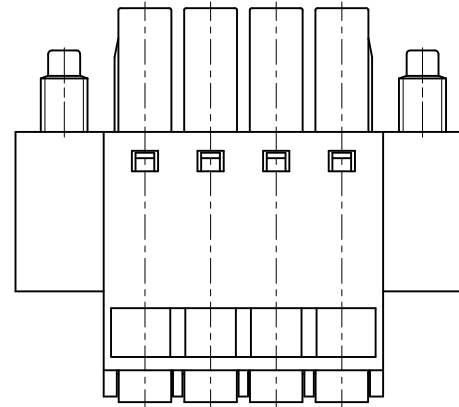
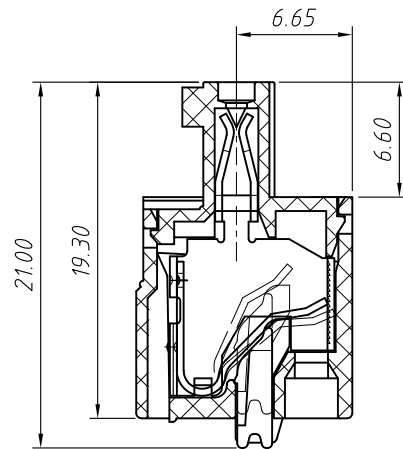
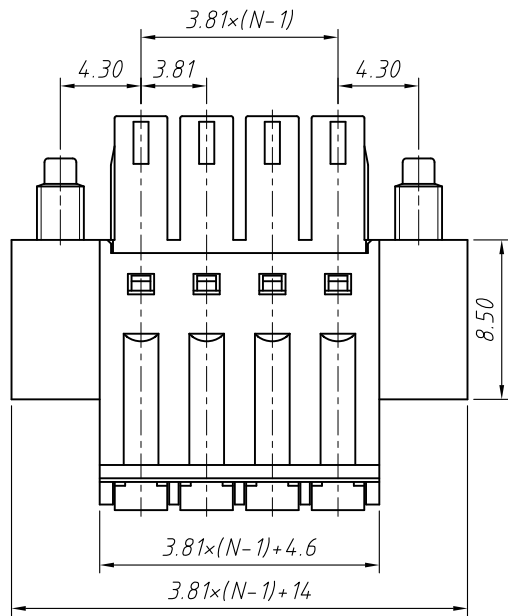

Material
 Housing: PA66, UL 94V-0
 Screws: M2.5, Steel, Zn Plated
 Clamp: Phosphor bronze, Ni Plated
 Wire guard: Stainless steel



Electrical
 Rated voltage: 300V
 Rated current: 8A
 Contact Resistance: 20 mΩ
 Insulation resistance: 500MΩ/DC500V
 Withstand voltage: AC2000V / 1 min
 Wire Range: 28 ~ 16AWG 1.0mm²

Mechanical
 Temp. Range: -40 °C ~ +105 °C
 Strip length: 7 ~ 8 mm
 Torque: 0.4Nm(3.6 bin)

Order Information

L-KLS2- EDGKDM -3.81-XXP-4 S 00

RoHS —
 Terminal Block —
 Pitch —
 No. of Pole —
 Color: 4- Green —
 Screw: S-Slot Screw C-Crass Screw —
 Product Code: 00 ~ 99 —

GENERAL TOLERANCE		ANGLE TOLERANCE		Description:	
X. ±0.60		X. ±5°		Pluggable Terminal Block 3.81MM	
.X ±0.38		.X ±3°		KLS P/N:	KLS2-EDGKDM-3.81-XXP-4S-00
.XX ±0.25		.XX ±2°		 NingBo KLS ELECTRONIC CO.,L TD.	
Draw by	2015-09-01	PROJECTION			
Check by	2015-09-15	UNITS	mm		
SCALE		SHEET SIZE	A4		