

PCB LAYOUT

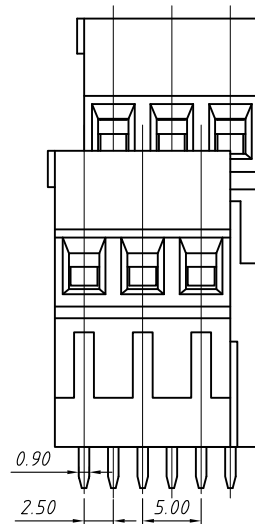
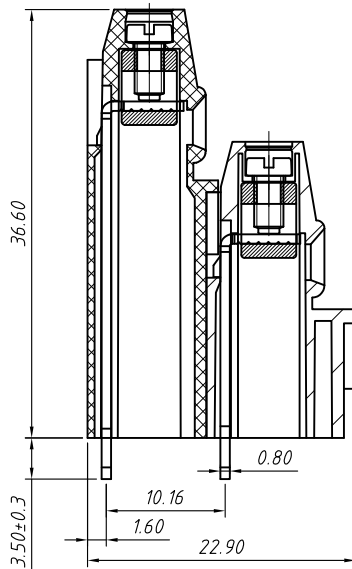
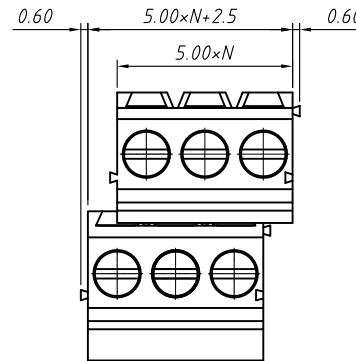

Material
Housing: PA66, UL94V-0
Pin header: Brass, Tin plated
Clamp: Brass, Ni plated
Screw: M2.5, steel Zinc plated

Electrical
Rated voltage: 300V
Rated current: 15A
Contact Resistance: 20 mΩ
Insulation resistance: 500MΩ/DC500V
Withstand voltage: AC2000V / 1 min
Wire Range: 30~14AWG 2.5mm²

Mechanical
Temp. Range: -40 °C ~ +105 °C
Strip length: 6~7mm
Torque: 0.4Nm (3.5Lb.in)

Order Information

L-KLS2-128B2-5.00-XXP-4 S 00

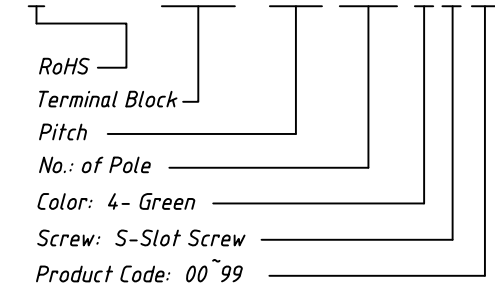

GENERAL TOLERANCE		ANGLE TOLERANCE		Description:	
X. ±0.60		X. ±5°		Screw CONN TERM Block 5.00mm	
.X ±0.38		.X ±3°		KLS P/N:	KLS2-128B2-5.00-XXP-4S
.XX ±0.25		.XX ±2°			
Draw by	2015-09-01	PROJECTION		NingBo KLS ELECTRONIC CO.,L TD.	
Check by	2015-09-15	UNITS	mm		
SCALE		SHEET SIZE	A4		

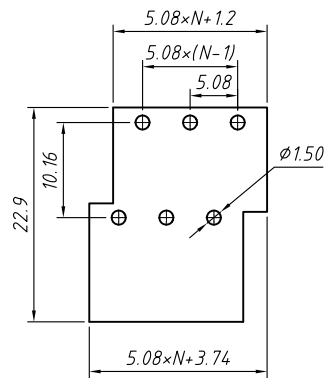

PCB LAYOUT

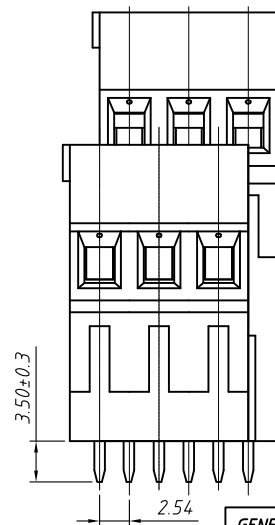
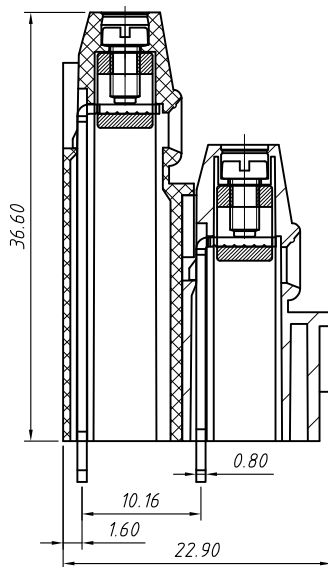
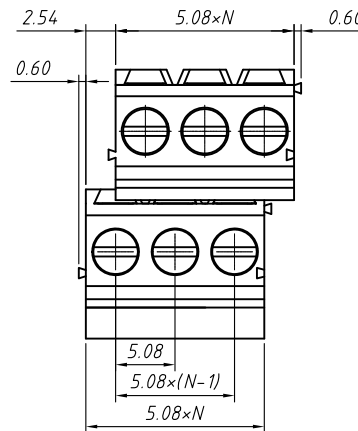

Material
Housing: PA66, UL94V-0
Pin header: Brass, Tin plated
Clamp: Brass, Ni plated
Screw: M2.5, steel Zinc plated

Electrical
Rated voltage: 300V
Rated current: 15A
Contact Resistance: 20 mΩ
Insulation resistance: 500MΩ/DC500V
Withstand voltage: AC2000V / 1 min
Wire Range: 30~14AWG 2.5mm²

Mechanical
Temp. Range: -40 °C ~ +105 °C
Strip length: 6~7mm
Torque: 0.4Nm (3.5Lb.in)

Order Information

L-KLS2-128B2-5.08-XXP-4 S 00

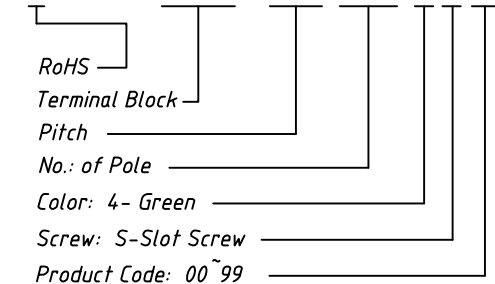

GENERAL TOLERANCE		ANGLE TOLERANCE		Description:	
X. ±0.60		X. ±5°		Screw CONN TERM Block 5.08mm	
.X ±0.38		.X ±3°		KLS P/N:	KLS2-128B2-5.08-XXP-4S
.XX ±0.25		.XX ±2°			
Draw by	2015-09-01	PROJECTION		NingBo KLS ELECTRONIC CO.,L TD.	
Check by	2015-09-15	UNITS	mm		
SCALE		SHEET SIZE	A4		