

**Material**  
 Housing: PA46 UL 94 V-0  
 Contacts: C5191-H, Gold flash over Nickel.  
 LEG: C2680-H, Gold flash over Nickel.

**Electrical**  
 Voltage Rating(Max.): 50V  
 Current Rating(Max.): 0.5A

**Mechanical**  
 Temp. Range: -40 °C ~ +80 °C

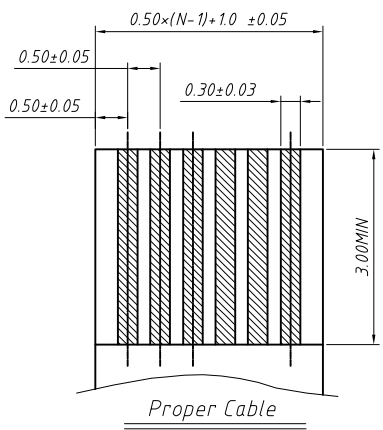
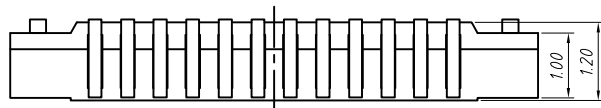
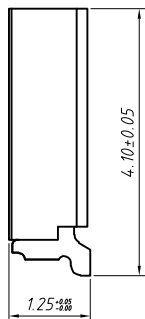
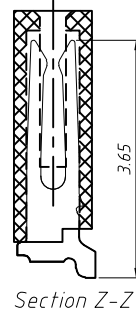
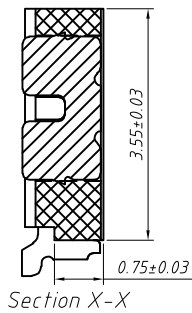
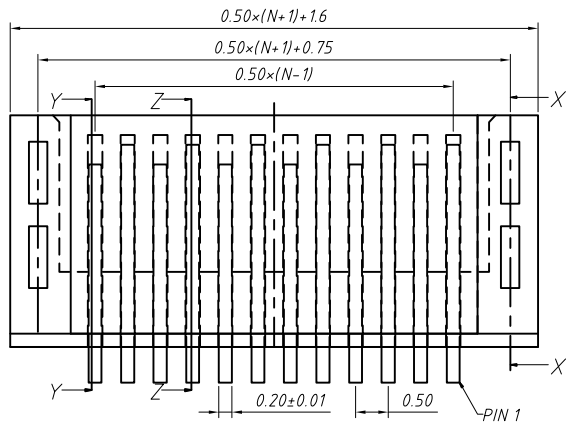

**Order Information**

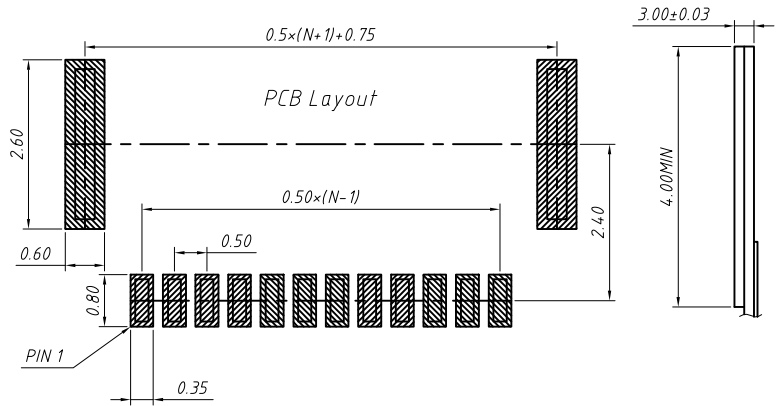
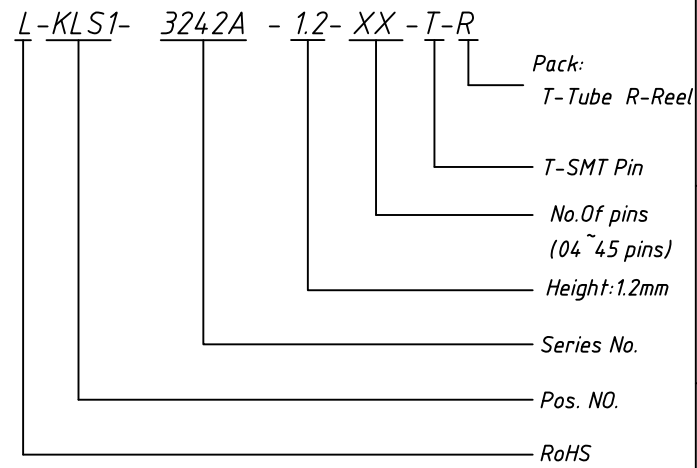

GENERAL TOLERANCE	ANGLE TOLERANCE	PROJECTION	Description:
X ±0.15	X ±5°	UNITS	CONN FFC 0.50mm, SMD, Horizontal, with ZIF
.X ±0.03	.X ±3°	SHEET SIZE	
.XX ±0.05	.XX ±2°	KLS P/N:	
Draw by: Date		2018-03-10	
Check by: Date		2018-03-10	
SCALE		SHEET OF	

**KLS** NingBo KLS ELECTRONIC CO., L TD.