

Nut

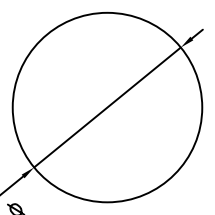

Panel Mounting
hole diameter

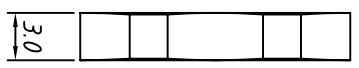
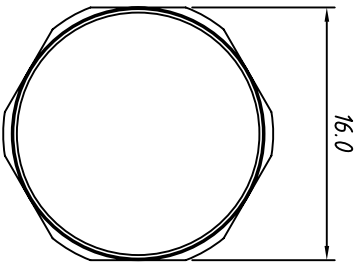

body

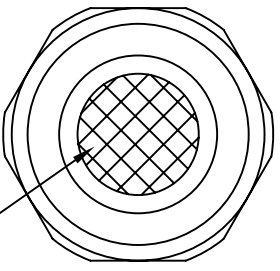
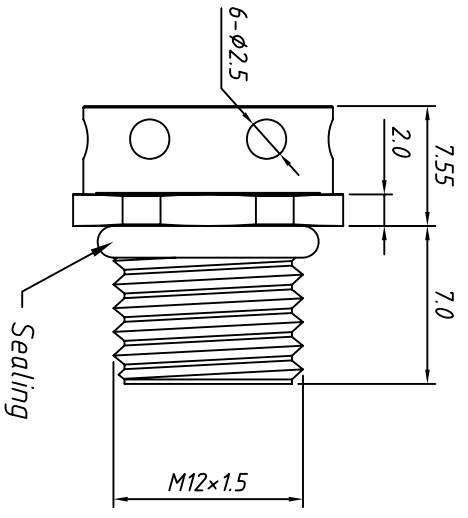

Film

- Material: Stainless steel
- Film: EPTFE
- Sealing: NBR, EPDM
- IP rating: IP67
- Thread: M12x1.5
- Panel Mounting: M12x1.5
- Temp. Range: -40 ° C ~ + 120 ° C
- breathable valve Range: 350ml/minute Max.
- Maximum torque: 8kgf.cm Max.

Order Information

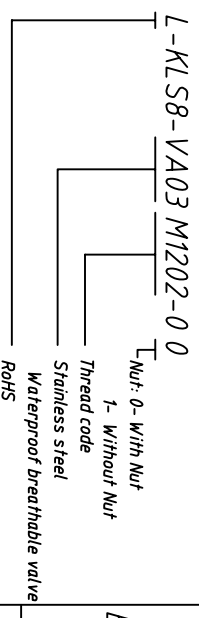

GENERAL TOLERANCE		ANGLE TOLERANCE		PROJECTION	
X. ±0.60	X. ±5°	.XX ±2°	mm	mm	mm
X ±0.38	.X ±3°				
XX ±0.25					
Draw 2018-01-20	Check 2018-01-20	SCALE	SHEET SIZE	A4	

Description:	KLS P/N:
M12x1.5 Stainless steel waterproof breathable valve	KLS8-VA03M1202-00

 NingBo KLS ELECTRONIC CO.,LTD.