



## AC Power Sockets\*AC Plugs

KLS1-AS-222-4 AC Power Sockets\*AC Plugs

### Material:

Material(External): Nylon PA66 PC  
Rating Voltage: 250V 10A  
Humidity: 93%+40  
Insulation:  $\geq 100M\Omega$   
Withstand Voltage: AC 500V(50Hz)/min

### Electrical Characteristics:

Conduct Material: COPPER  
Temperature Range:  $-40^{\circ}C + 70^{\circ}C$   
Contact Resistance:  $\leq 0.03\Omega$   
Actuating Force: 5-40N  
Lifespan: 10000times

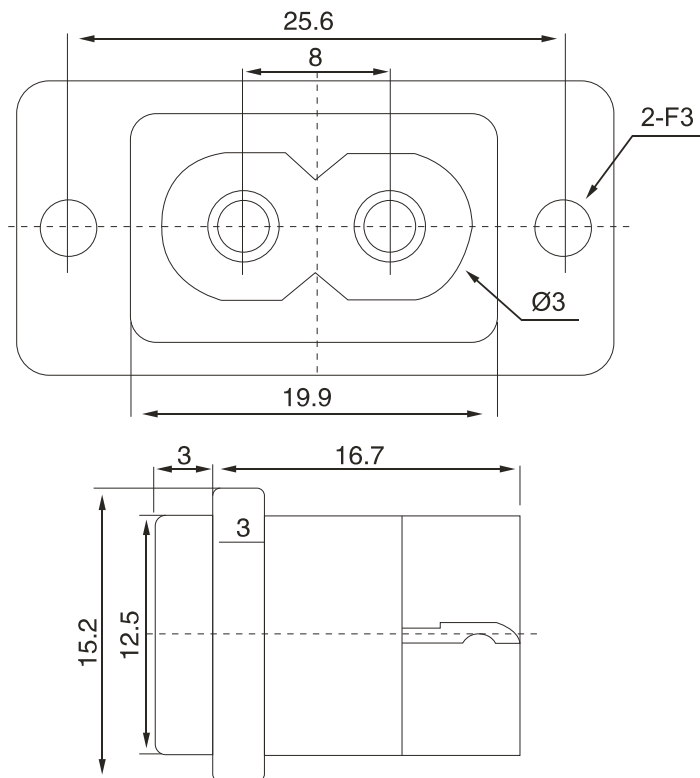

## ORDER INFORMATION

Product NO.: KLS1 - AS-222-4

