

Coin Cell Holders

KLS5-CR2477-2 CR2477 Coin Battery Holder

I

Material:

Housing: PBT
Contacts: Phosphor Bronze, Nickel plating

Electrical Characteristics:

Insulator Resistance: 1000M Ohm min.
Contact Resistance: 30m Ohm max.
Dielectric voltage: 500V AC
Operating Temperature: -25°C~+85°C

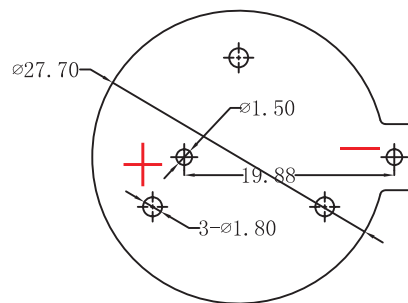
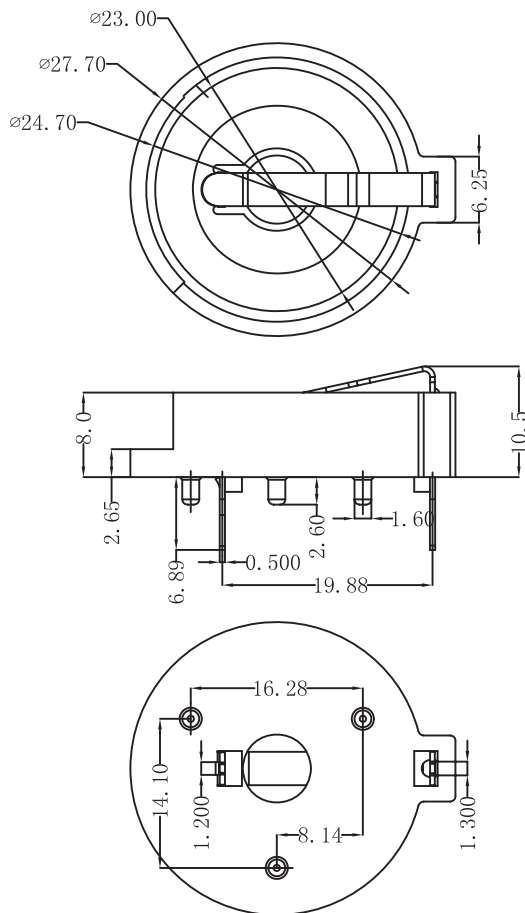
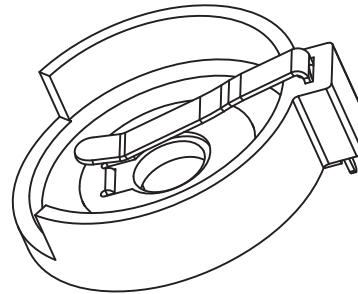

PCB Layout Diagram
Top View

ORDER INFORMATION

Product NO.: KLS5-CR2477-2

