

Mini Microphone

Noise Cancelling mini microphone MN6027 Serie

Specifications:

Sensitivity(1KHz,0dB=1V/Pa):-38±3dB;-40±3dB; -42±3dB; -44±3dB;

Directivity:Noise Cancelling

Impedance:2.2KΩ Max.

Current consumption:0.5mA Max.

Operation voltage:1.0~10V

S/N ratio:60dB Min.

Sensitivity vs. Voltage:3dB Max. at VS=2.0V~1.5V

Std. Test Condition:94dB S.P.L @1KHz VS=2.0V

Frequency:20~16,000Hz

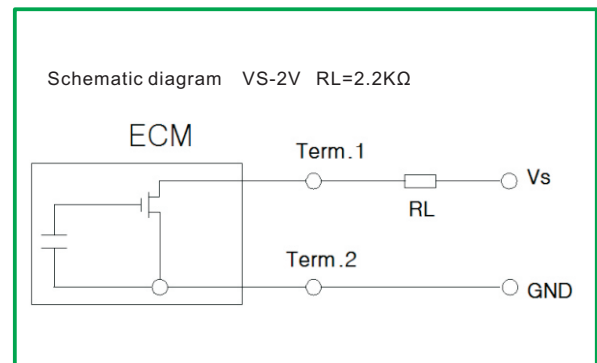
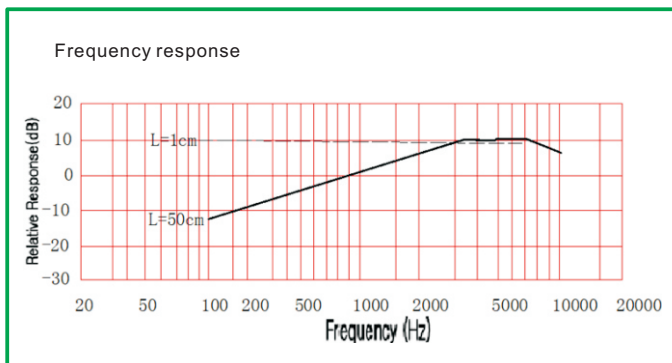
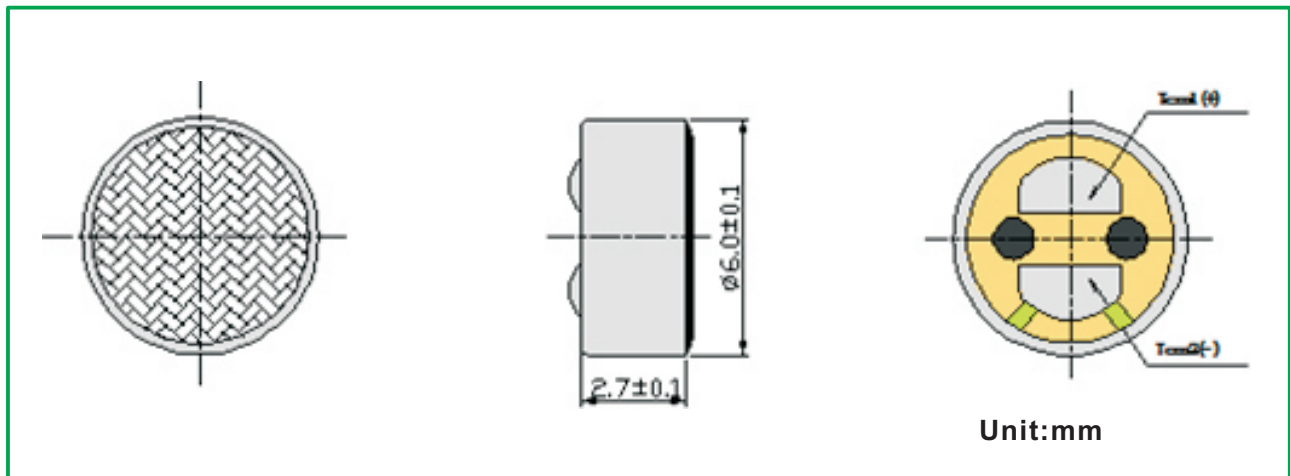

ORDER INFORMATION

Product NO.: **KLS3 - MN 6027 P - 423**

Noise Cancelling mini microphone Series

Dimensions

Note: Soldering

P: Pin Type

W: Wire type

Sensitivity