

Push Button Switches

KLS7-KAN8-208 Push Button Switches

Electrical:

1. Rated load: 0.5A 50V DC
2. Contact Resistance: $\leq 100m\Omega$
3. Insulation Resistance: $\geq 100M\Omega$
4. Withstand Voltage: 500V AC 1minute
5. Actuating Force: $750g \pm 50g$
6. Electrically Life: ≥ 50000 cycles
7. Environment temperature: $-40^{\circ}C \sim +70^{\circ}C$

Materials:

1. Base: POM
2. Cover: POM
3. Upper teeth: POM
4. Bottom teeth: POM
5. The needle: H62 brass band $Y1 = 0.38mm$
6. Short Needle: H62 brass band $Y1 = 0.38mm$
7. Contact sheet: H65 brass band $TM = 0.3mm$

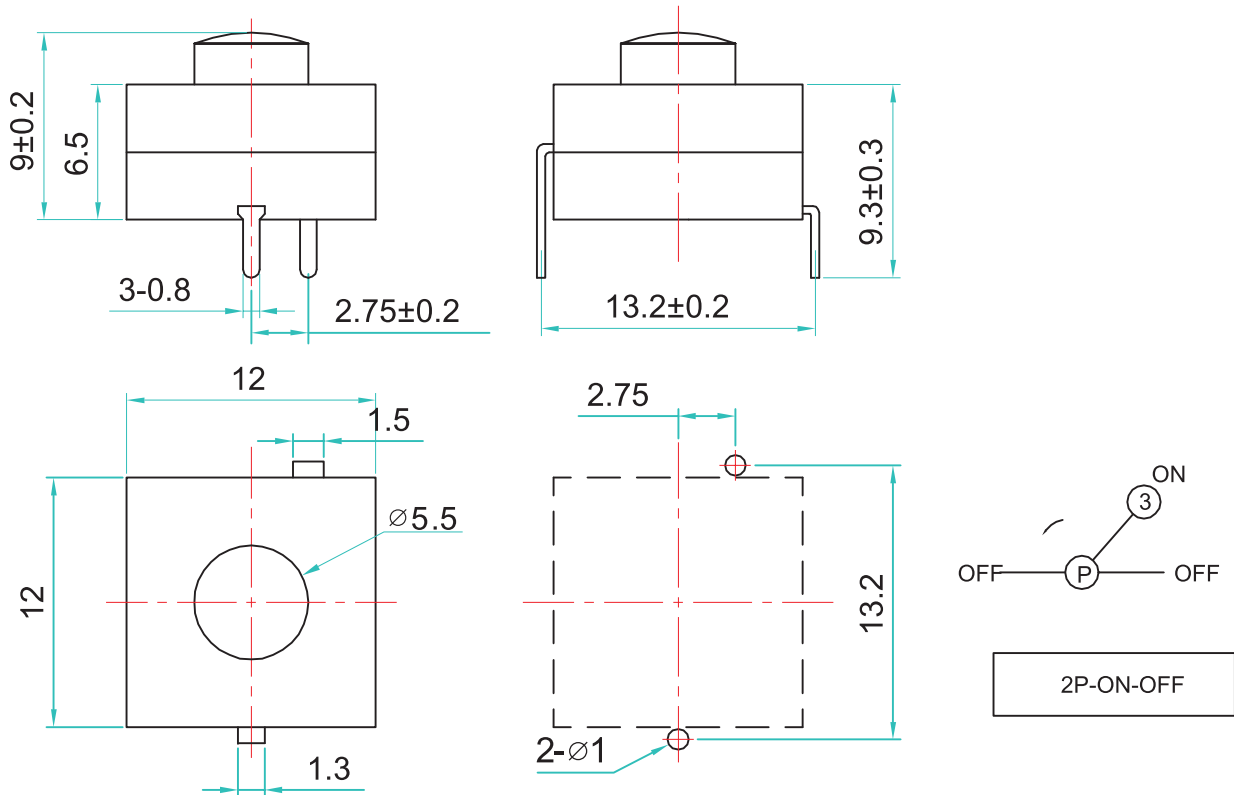

ORDER INFORMATION

Product NO.: KLS7-KAN8-208

