

Push Button Switches

KLS7-MPS-1CO-A4 Momentary Pushbutton Switch

Specification:

Rating: 1A 250V AC; 3A 125V AC
 Contact resistance: 20mΩ Max
 Insulation resistance: 1000MΩ/500VDC Min
 Withstanding Voltage: AC1000V/1Min
 Electrical life: 10000 Cycles
 Operating Temperature: -25°C~+85°



NO.	Parts Name	The Parts Of Material	Electroplating	RoHS
1	Pole	PA46	-----	RoHS
2	Spring	Steel wire	-----	RoHS
3	Bushing	Brass	Plate Nickel	RoHS
4	Supporting Halt	Brass	-----	RoHS
5	Sliding Point	Bakelite	-----	RoHS
6	Housing	Bakelite	-----	RoHS
7	Movable Plate	Brass	Plate Silver	RoHS
8	Terminals	Brass	Plate Silver	RoHS
9	Steel crust	Stainless Steel	-----	RoHS
10	Epoxy Seal	5010A/B	-----	RoHS

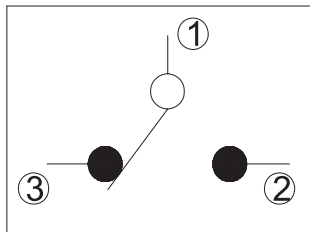

Circuit Diagram

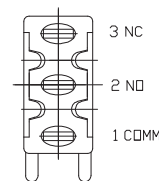
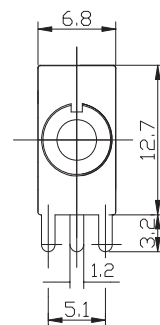
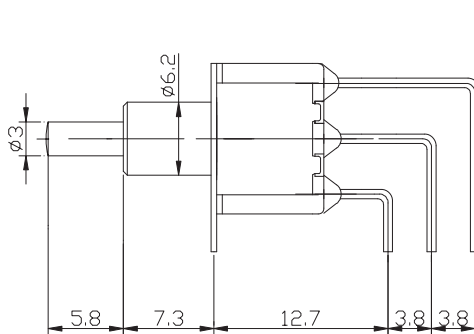
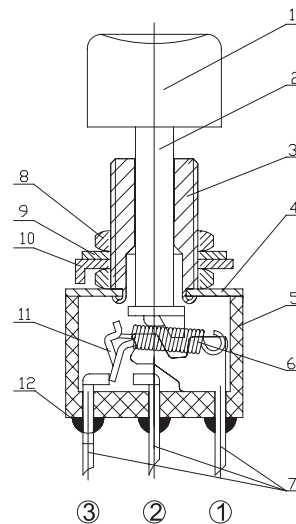

ORDER INFORMATION

L-KLS7-MPS-1CO-A4

Part Number

Momentary Pushbutton Switch

Function: Without Lock

Push Button Switches

KLS7-MPS-1CO-A4L Momentary Pushbutton Switch

Specification:

Rating: 1A 250V AC; 3A 125V AC
 Contact resistance: 20mΩ Max
 Insulation resistance: 1000MΩ/500VDC Min
 Withstanding Voltage: AC1500V/1Min
 Electrical life: 10000 Cycles
 Operating Temperature: -25°C~+85°C

NO.	Parts Name	The Parts Of Material	Electroplating	RoHS
1	Button	PA46	-----	RoHS
2	Pole	PA46	-----	RoHS
3	Bushing	Brass	Nickel Plating	RoHS
4	Steel crust	Stainless Steel	-----	RoHS
5	Housing	Bakelite	-----	RoHS
6	Spring	Steel wire	-----	RoHS
7	Terminals	Brass	Silver Plating	RoHS
8	Nuts	Brass	Nickel Plating	RoHS
9	Zigzag Washer	Stainless Steel	-----	RoHS
10	Fix Washer	Stainless Steel	-----	RoHS
11	Movable Plate	Brass	Silver Plating	RoHS
12	Epoxy Seal	5010A/B	-----	RoHS

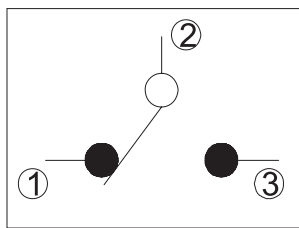

Circuit Diagram

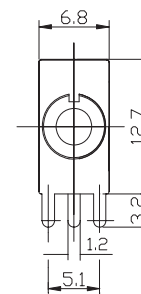
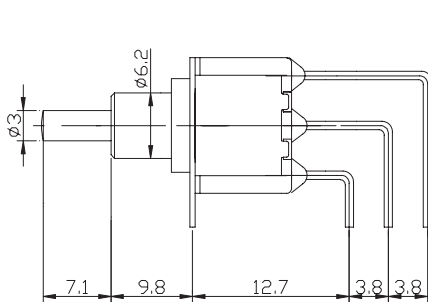
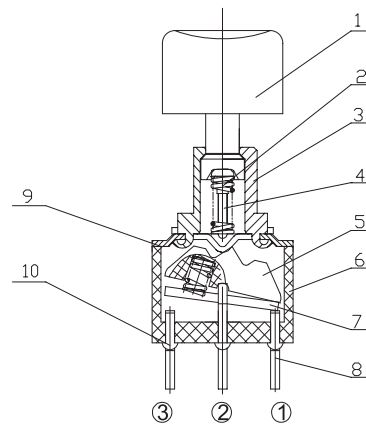

ORDER INFORMATION

L-KLS7-MPS-1CO-A4L

Part Number

Momentary Pushbutton Switch

Function: L=With Lock