

XLR CONNECTOR SERIES

KLS1-XLR-S02 (XLR Socket)

Electrical Specification:

- Contact resistance: $\leq 0.03\Omega$
- Insulation resistance: $\geq 100m\Omega$
- Withstand voltage: 500V AC (50Hz)/minute
- Rated load: 50V DC, 1A
- Insertion and extraction force: 4-40N
- Temperature range: $-30^{\circ}C$ to $+80^{\circ}C$

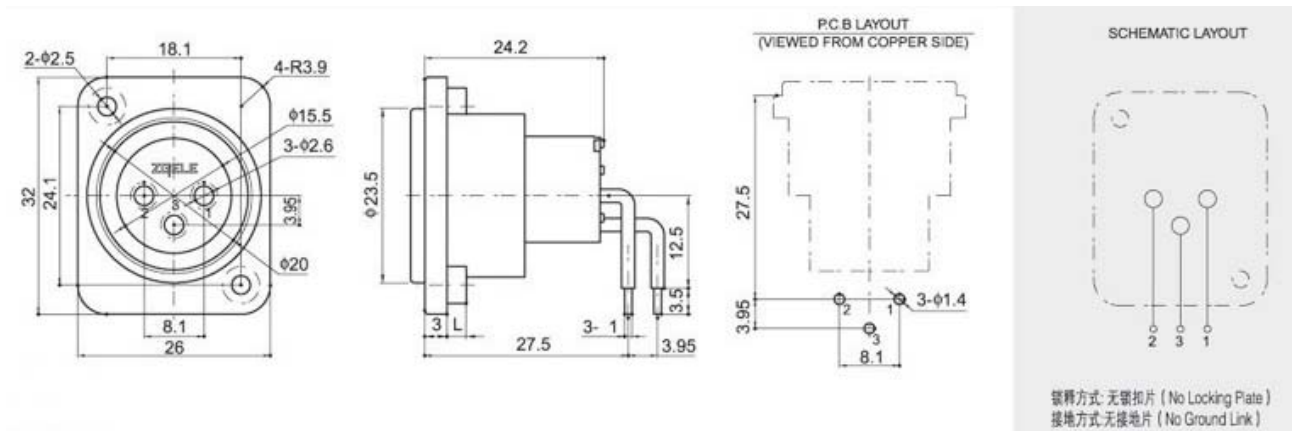
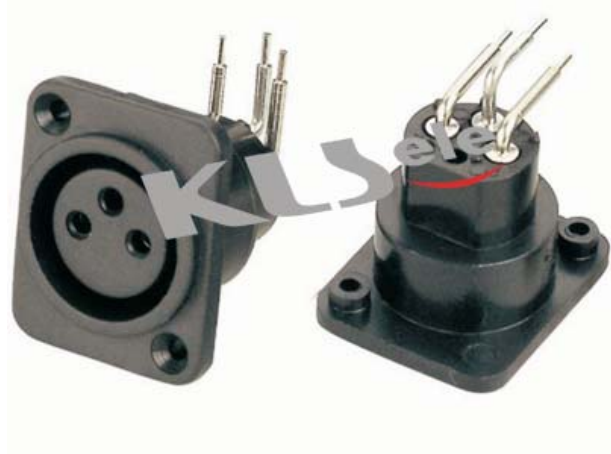

ORDER INFORMATION

Product NO.:KLS1-XLR-S02-03-F-R-L2.6

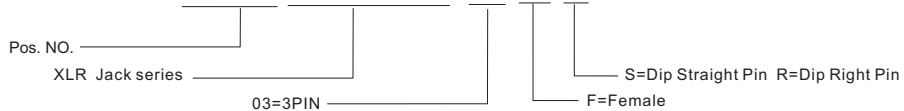

XLR CONNECTOR SERIES

KLS1-XLR-S02 (XLR Socket)

Electrical Specification:

- Contact resistance: $\leq 0.03\Omega$
- Insulation resistance: $\geq 100m\Omega$
- Withstand voltage: 500V AC (50Hz)/minute
- Rated load: 50V DC, 1A
- Insertion and extraction force: 4-40N
- Temperature range: -30° C to + 80° C

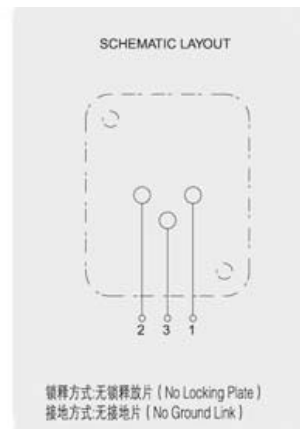
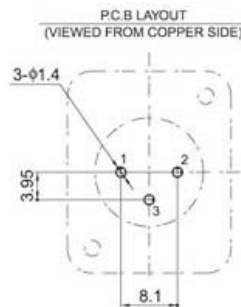
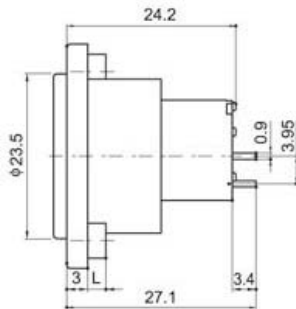
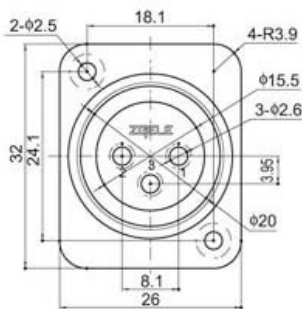

ORDER INFORMATION

Product NO.:KLS1-XLR-S02-03-F-S-L2.6

