

Switch

Rocker Switch Series

KLS7-017 Rocker Switch Series

MATERIAL

1. Housing: Nylon 66
2. Rocker: PC & PA66
3. Contacts: Silver Alloy
4. Terminal: Brass Silver Plated
5. Lamp: Neon Lamp, Tungsten Lamp
6. Spring: SWP,SUS
7. Movable Arm: Brass Silver Plated



ELECTRICAL

1. Electrical Rating: 6(4)A 250VAC /10A 125VAC
2. Mechanical life: Over 30000 Cycles
3. Electrical life: Over 10000 Cycles
4. Contact Resistance: $\leq 50m\Omega$
5. Insulation Resistance: $\geq 100M\Omega$
6. High Voltage Resistance: $>1500V$ 1 min
7. Ambient Temperature: Terminal Side $-20^{\circ}C \sim +85^{\circ}C$;
Actuating Side $-20^{\circ}C \sim +55^{\circ}C$
8. Storage Temperature: $-30^{\circ}C \sim +80^{\circ}C$ Max
9. Atmospheric Humidity: Max 85%
10. Actuating force: 4~8N (depends on different switch function)
11. Flammability: UL94 V-2
12. Temperature rise at the terminal: Max $30^{\circ}C$ (UI1054)
13. Solder ability of terminal: Max $350^{\circ}C$ 3S

Panel hole size

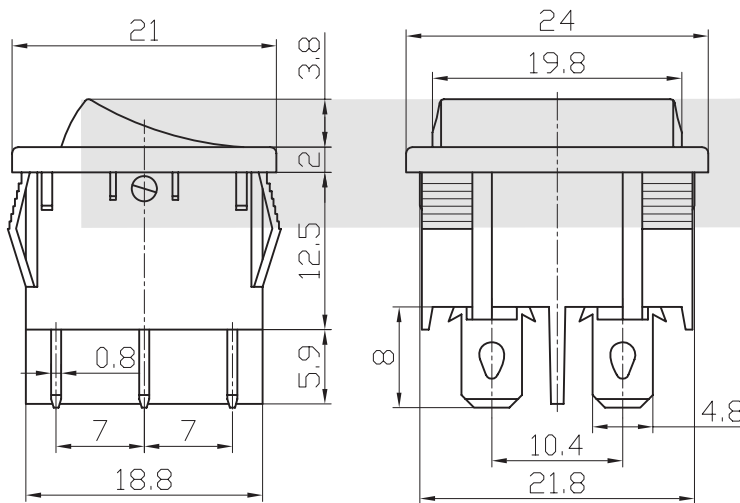
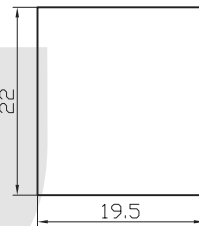

SWITCHING CIRCUIT

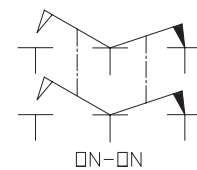

ORDER INFORMATION

