

## BNC Connector Series

### KLS1-BNC005 BNC Connector Series

#### Electrical Specifications

Impedance: 50 Ω nominal  
 Frequency Range: 0-4 GHz with low reflection  
 Voltage Rating: 500 volts peak  
 Dielectric Withstanding Voltage: 1,500 volts rms  
 VSWR :Straight connectors: 1.3 max 0-4 GHz  
           Right angle connectors: 1.35 max 0-4 GHz  
 Contact Resistance  
     Center contact: 1.5 mΩ;  
     Outer contact: 0.2 mΩ  
 Insulation Resistance: 5,000 MΩ  
 Braid to Body: 0.1 milliohm  
 RF Leakage: -55 dB min at 3 GHz  
 Insertion Loss: 0.2 dB min at 3 GHz  
 Temperature Range: - 65°C to + 165°C

#### Material

Male Contact: Brass  
 Female Contact: Beryllium copper or phosphorous bronze, silver or gold-plated  
 Other Metal Parts: Brass, nickel finish  
 Insulator: TFE  
 Crimp Ferrule: Copper/brass

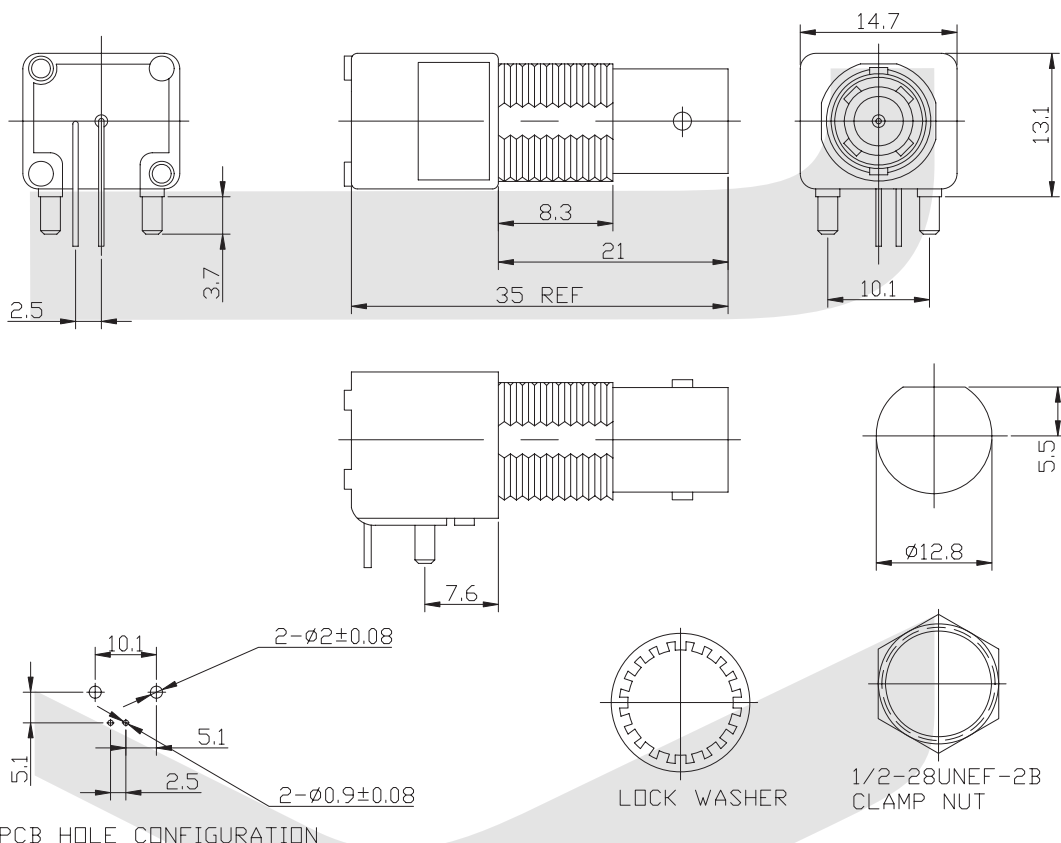

## ORDER INFORMATION

Product NO.: KLS1-BNC005

Pos. NO. \_\_\_\_\_  
 BNC Connector Type \_\_\_\_\_