

## DIN 41612 Series

KLS1-D3 3X32Pin 3 row Long C Type

### Electrical:

Contact Resistance: 30 mΩ Max. Insulator  
 Insulation Resistance: 1000 MΩ Min. At 500 VDC  
 Withstand Voltage: 1000 VAC for 1 minute  
 Current Rating: 2 AMP  
 Voltage Rating: 250 VAC  
 Operating Temperature: -55 °C ~ +105 °C

### Material:

Insulator: Glass-filled thermoplastic PBT UL94V-0  
 Contacts: Male-Brass / Female-Phosphor Bronze  
 Plating: full gold or selected gold in mating area.

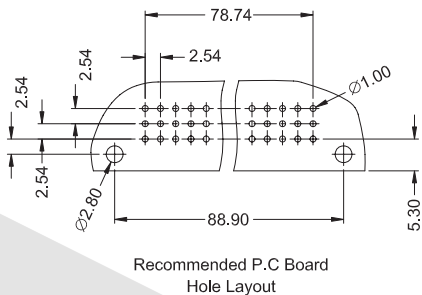
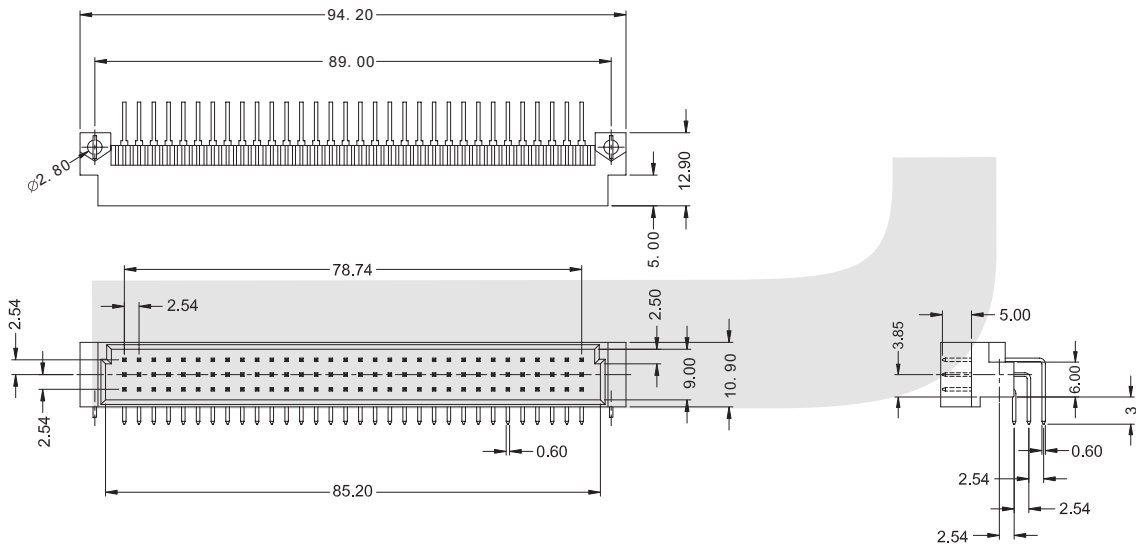
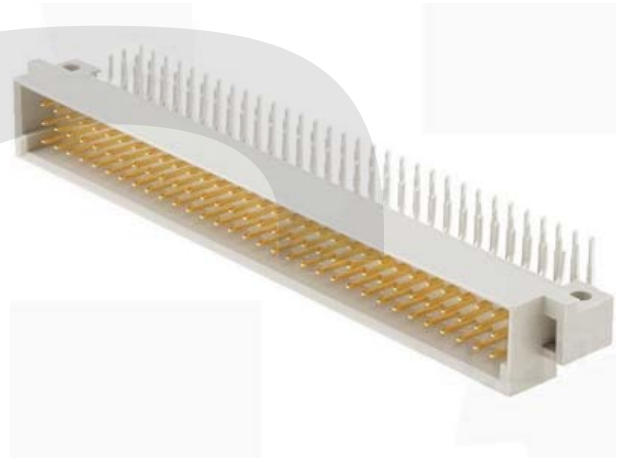

Pitch	Position	Rows with Contacts	Contact Arrange	Part Number
2.54mm	96	a b c		3396
	64	a - c		3264
5.08mm	48	a b c		3348
	32	a - c		3232

## ORDER INFORMATION

Product No.: KLS1-D3-3396-MR

Pos. No. \_\_\_\_\_ Tail Style: S -4.0mm Straight pin  
 3X32Pin 3 row Long Type \_\_\_\_\_ W1-13mm Straight pin  
 Part Number: 3396 / 3264 / 3348 / 3232 \_\_\_\_\_ R -Right pin  
 Contact Type: M=Male Plug  
 F=Female Receptacle

## DIN 41612 Series

KLS1-D3 3X32Pin 3 row Long C Type

### Electrical:

Contact Resistance: 30 mΩ Max. Insulator  
Insulation Resistance: 1000 MΩ Min. At 500 VDC  
Withstand Voltage: 1000 VAC for 1 minute  
Current Rating: 2 AMP  
Voltage Rating: 250 VAC  
Operating Temperature: -55 °C ~ +105 °C

### Material:

Insulator: Glass-filled thermoplastic PBT UL94V-0  
Contacts: Male-Brass / Female-Phosphor Bronze  
Plating: full gold or selected gold in mating area.

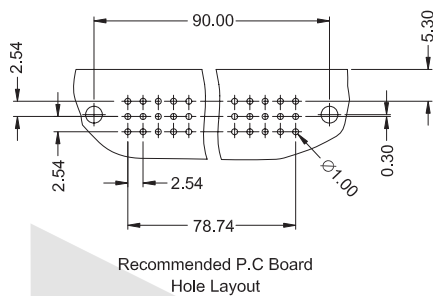
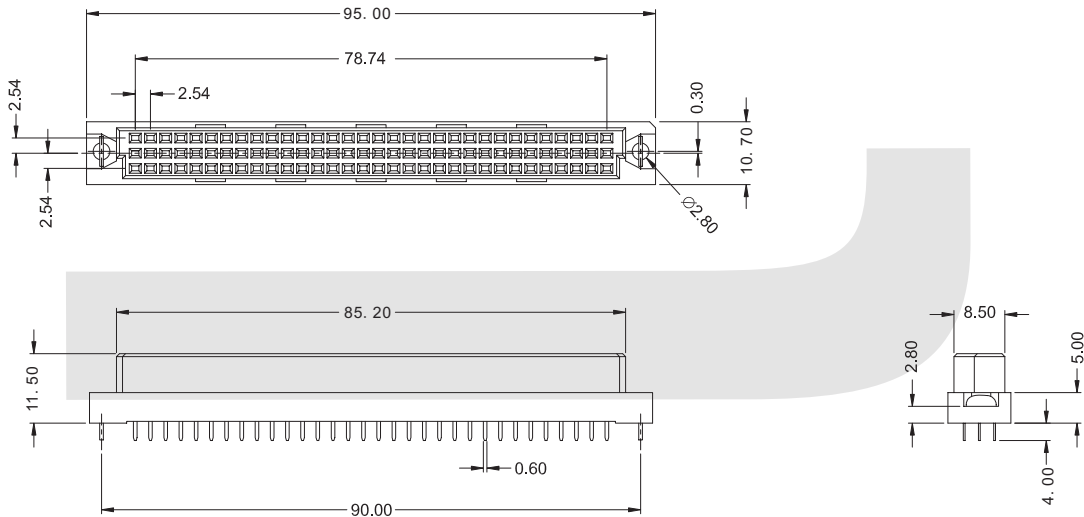
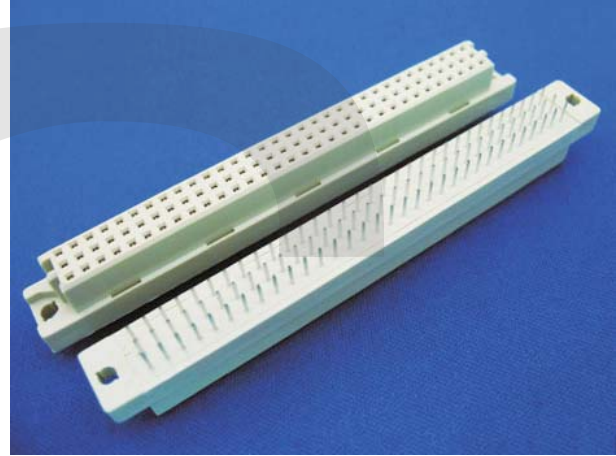

Pitch	Position	Rows with Contacts	Contact Arrange	Part Number
2.54mm	96	a b c		3396
	64	a - c		3264
5.08mm	48	a b c		3348
	32	a - c		3232

## ORDER INFORMATION

Product No.: KLS1-D3-3396-F S

Pos. No. \_\_\_\_\_ Tail Style: S -4.0mm Straight pin  
W1-13mm Straight pin  
R -Right pin  
3X32Pin 3 row Long Type \_\_\_\_\_ Contact Type: M=Male Plug  
F=Female Receptacle  
Part Number: 3396 / 3264 / 3348 / 3232 \_\_\_\_\_

## DIN 41612 Series

KLS1-D3 3X32Pin 3 row Long C Type

### Electrical:

Contact Resistance: 30 mΩ Max. Insulator  
Insulation Resistance: 1000 MΩ Min. At 500 VDC  
Withstand Voltage: 1000 VAC for 1 minute  
Current Rating: 2 AMP  
Voltage Rating: 250 VAC  
Operating Temperature: -55 °C ~ +105 °C

### Material:

Insulator: Glass-filled thermoplastic PBT UL94V-0  
Contacts: Male-Brass / Female-Phosphor Bronze  
Plating: full gold or selected gold in mating area.

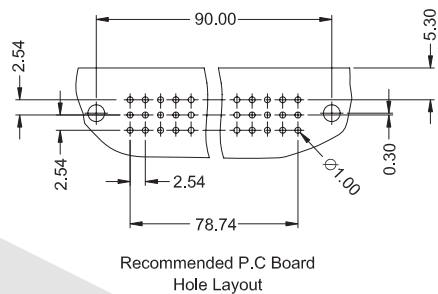
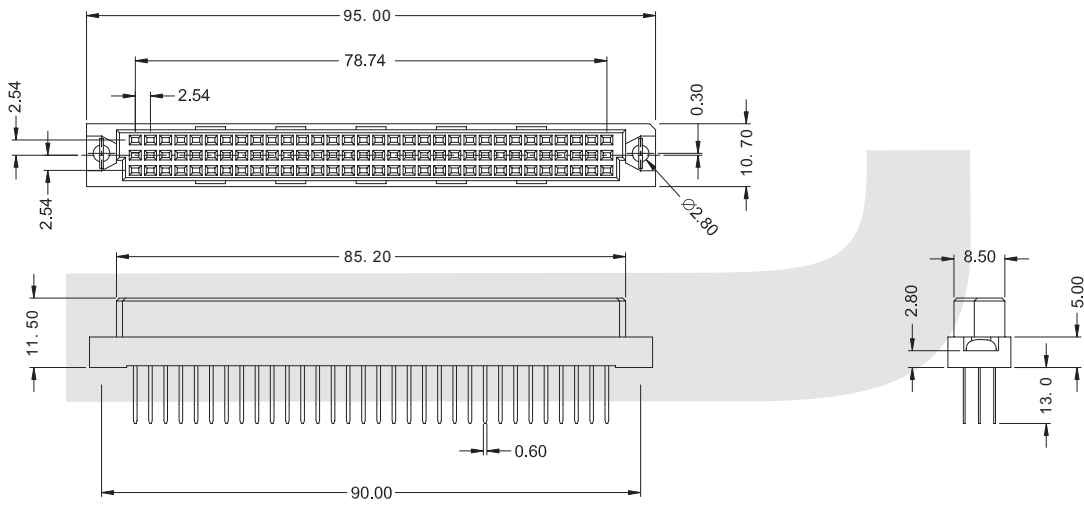

Pitch	Position	Rows with Contacts	Contact Arrange	Part Number
2.54mm	96	a b c		3396
	64	a - c		3264
5.08mm	48	a b c		3348
	32	a - c		3232

## ORDER INFORMATION

Product No.: KLS1-D3-3396-F W1

Pos. No. \_\_\_\_\_ Tail Style: S -4.0mm Straight pin  
W1-13mm Straight pin  
R -Right pin  
3X32Pin 3 row Long Type \_\_\_\_\_ Contact Type: M=Male Plug  
F=Female Receptacle  
Part Number: 3396 / 3264 / 3348 / 3232 \_\_\_\_\_

## DIN 41612 Series

KLS1-D3 3X32Pin 3 row Long R Type

### Electrical:

Contact Resistance: 30 mΩ Max. Insulator  
Insulation Resistance: 1000 MΩ Min. At 500 VDC  
Withstand Voltage: 1000 VAC for 1 minute  
Current Rating: 2 AMP  
Voltage Rating: 250 VAC  
Operating Temperature: -55 °C ~ +105 °C

### Material:

Insulator: Glass-filled thermoplastic PBT UL94V-0  
Contacts: Male-Brass / Female-Phosphor Bronze  
Plating: full gold or selected gold in mating area.

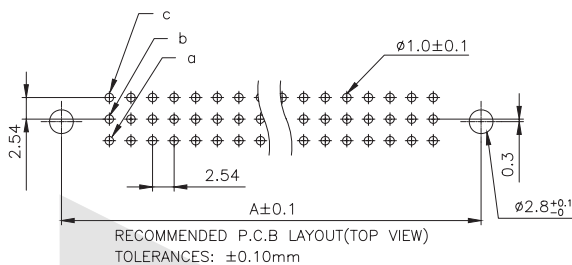
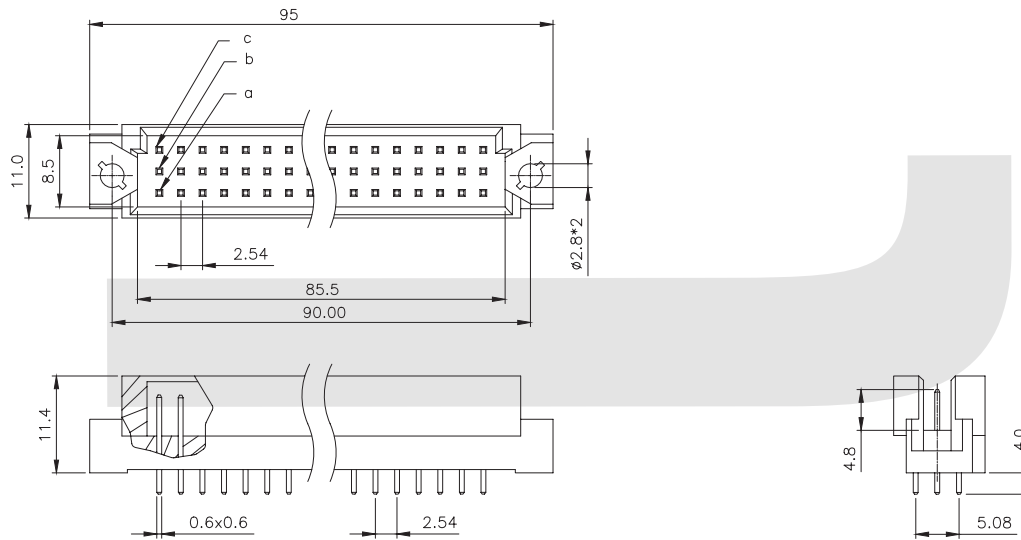
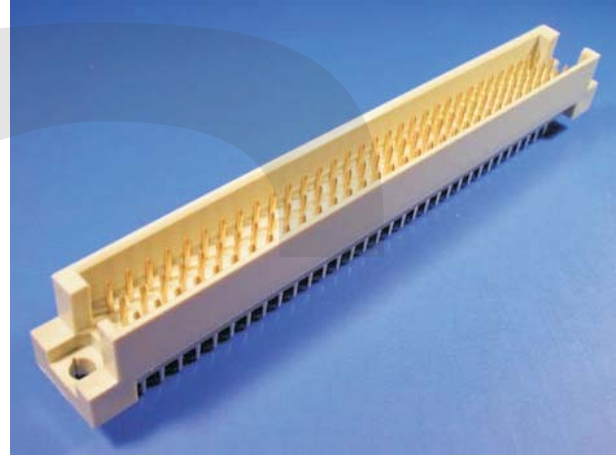

Pitch	Position	Rows with Contacts	Contact Arrange	Part Number
2.54mm	96	a b c		3396
	64	a - c		3264
5.08mm	48	a b c		3348
	32	a - c		3232

## ORDER INFORMATION

Product No.: KLS1-D3-3396-MS

Pos. No. \_\_\_\_\_ Tail Style: S -4.0mm Straight pin  
W1-13mm Straight pin  
R -Right pin  
3X32Pin 3 row Long Type \_\_\_\_\_ Contact Type: M=Male Plug  
F=Female Receptacle  
Part Number: 3396 / 3264 / 3348 / 3232 \_\_\_\_\_

## DIN 41612 Series

KLS1-D3 3X32Pin 3 row Long R Type

### Electrical:

Contact Resistance: 30 mΩ Max. Insulator  
Insulation Resistance: 1000 MΩ Min. At 500 VDC  
Withstand Voltage: 1000 VAC for 1 minute  
Current Rating: 2 AMP  
Voltage Rating: 250 VAC  
Operating Temperature: -55 °C ~ +105 °C

### Material:

Insulator: Glass-filled thermoplastic PBT UL94V-0  
Contacts: Male-Brass / Female-Phosphor Bronze  
Plating: full gold or selected gold in mating area.

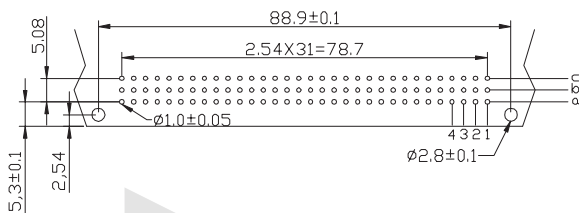
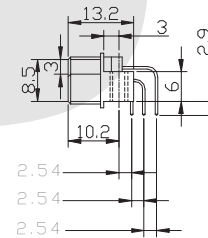
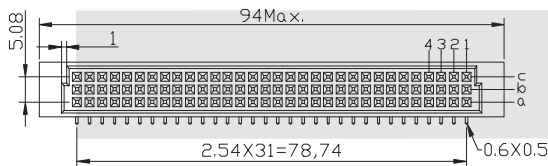
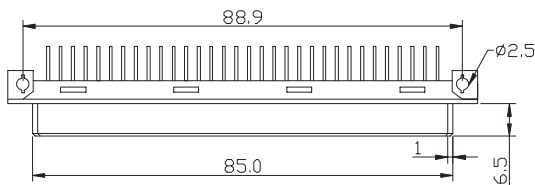
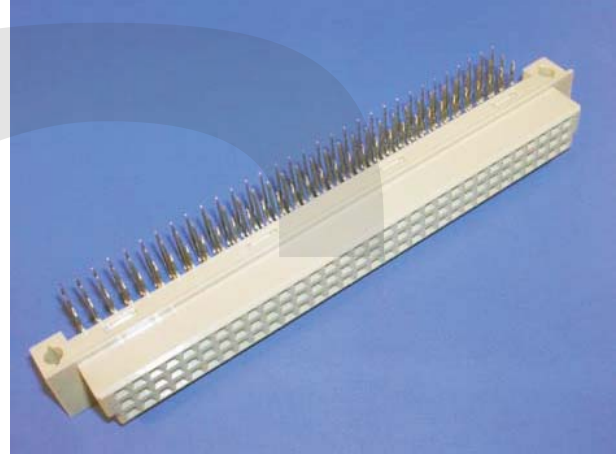

P.C. Board Layout

Pitch	Position	Rows with Contacts	Contact Arrange	Part Number
2.54mm	96	a b c		3396
	64	a - c		3264
5.08mm	48	a b c		3348
	32	a - c		3232

## ORDER INFORMATION

Product No.: KLS1-D3-3396-F R

Pos. No. \_\_\_\_\_ Tail Style: S -4.0mm Straight pin  
W1-13mm Straight pin  
R -Right pin  
3X32Pin 3 row Long Type \_\_\_\_\_ Contact Type: M=Male Plug  
F=Female Receptacle  
Part Number: 3396 / 3264 / 3348 / 3232 \_\_\_\_\_

## DIN 41612 Series

KLS1-D3 3X32Pin 3 row Long R Type

### Electrical:

Contact Resistance: 30 mΩ Max. Insulator  
Insulation Resistance: 1000 MΩ Min. At 500 VDC  
Withstand Voltage: 1000 VAC for 1 minute  
Current Rating: 2 AMP  
Voltage Rating: 250 VAC  
Operating Temperature: -55 °C ~ +105 °C

### Material:

Insulator: Glass-filled thermoplastic PBT UL94V-0  
Contacts: Male-Brass / Female-Phosphor Bronze  
Plating: full gold or selected gold in mating area.

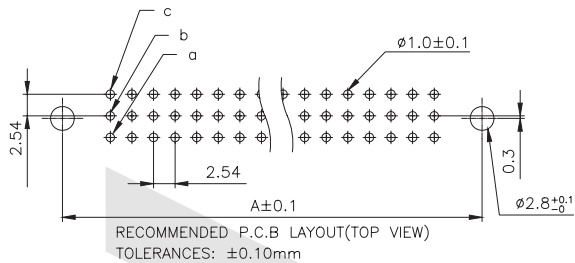
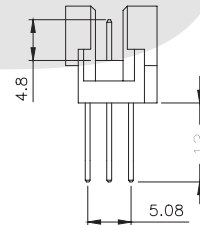
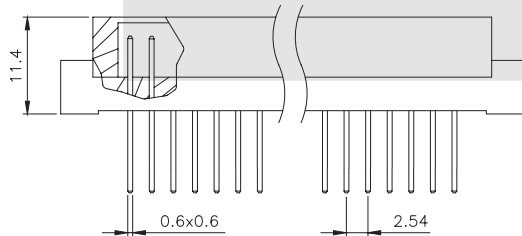
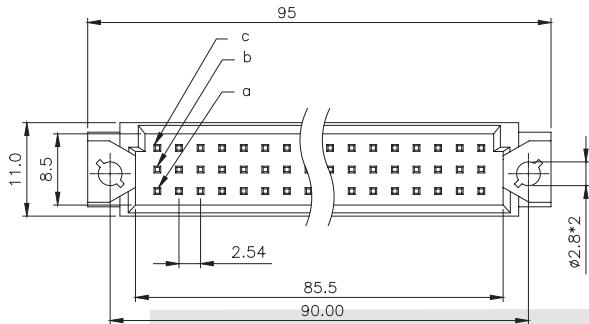
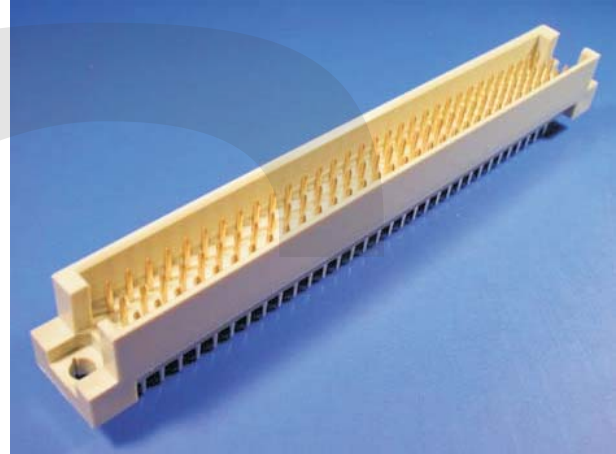

Pitch	Position	Rows with Contacts	Contact Arrange	Part Number
2.54mm	96	a b c		3396
	64	a - c		3264
5.08mm	48	a b c		3348
	32	a - c		3232

## ORDER INFORMATION

Product No.: KLS1-D3-3396-M W1

Pos. No. \_\_\_\_\_ Tail Style: S -4.0mm Straight pin  
W1-13mm Straight pin  
R -Right pin  
3X32Pin 3 row Long Type  
Part Number: 3396 / 3264 / 3348 / 3232  
Contact Type: M=Male Plug  
F=Female Receptacle